



---

## *Robotics 2*

# Visual servoing

Prof. Alessandro De Luca

DIPARTIMENTO DI INGEGNERIA INFORMATICA  
AUTOMATICA E GESTIONALE ANTONIO RUBERTI



SAPIENZA  
UNIVERSITÀ DI ROMA



# Visual servoing

---

- objective  
use information acquired by **vision sensors** (cameras) for **feedback control** of the pose/motion of a robot (or of parts of it)
- ⊕ data acquisition  $\sim$  human eye, with very large information content in the acquired images
- ⊖ difficult to extract essential data, nonlinear perspective transformations, high sensitivity to ambient conditions (lightening), noise



# Some applications

automatic navigation of robotic systems (agriculture, automotive)

video



video

surveillance



video

bio-motion synchronization (surgical robotics)

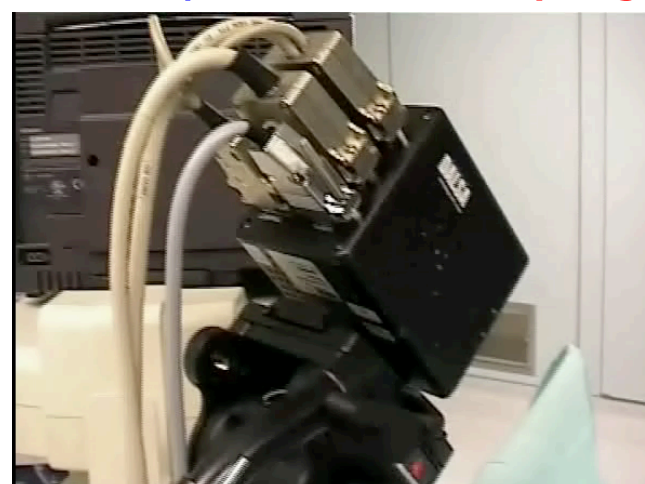

video



# Image processing

---

- **real-time** extraction of characteristic parameters useful for robot motion control
  - **features:** points, area, geometric center, higher-order moments, ...
- low-level processing
  - binarization (threshold on grey levels), equalization (histograms), edge detection, ...
- segmentation
  - based on regions (possibly in binary images)
  - based on contours
- interpretation
  - association of characteristic parameters (e.g., texture)
  - problem of **correspondence** of points/characteristics of objects in different images (stereo or on image flows)



# Configuration of a vision system

---

- one, two, or more cameras
  - grey-level or color
- 3D/stereo vision
  - obtained even with a single (moving) camera, with the object taken from different (known) points of view
- camera positioning
  - fixed (eye-to-hand)
  - mounted on the manipulator (eye-in-hand)
- robotized vision heads
  - motorized (e.g., stereo camera on humanoid head or pan-tilt camera on Magellan mobile robot)



# Camera positioning

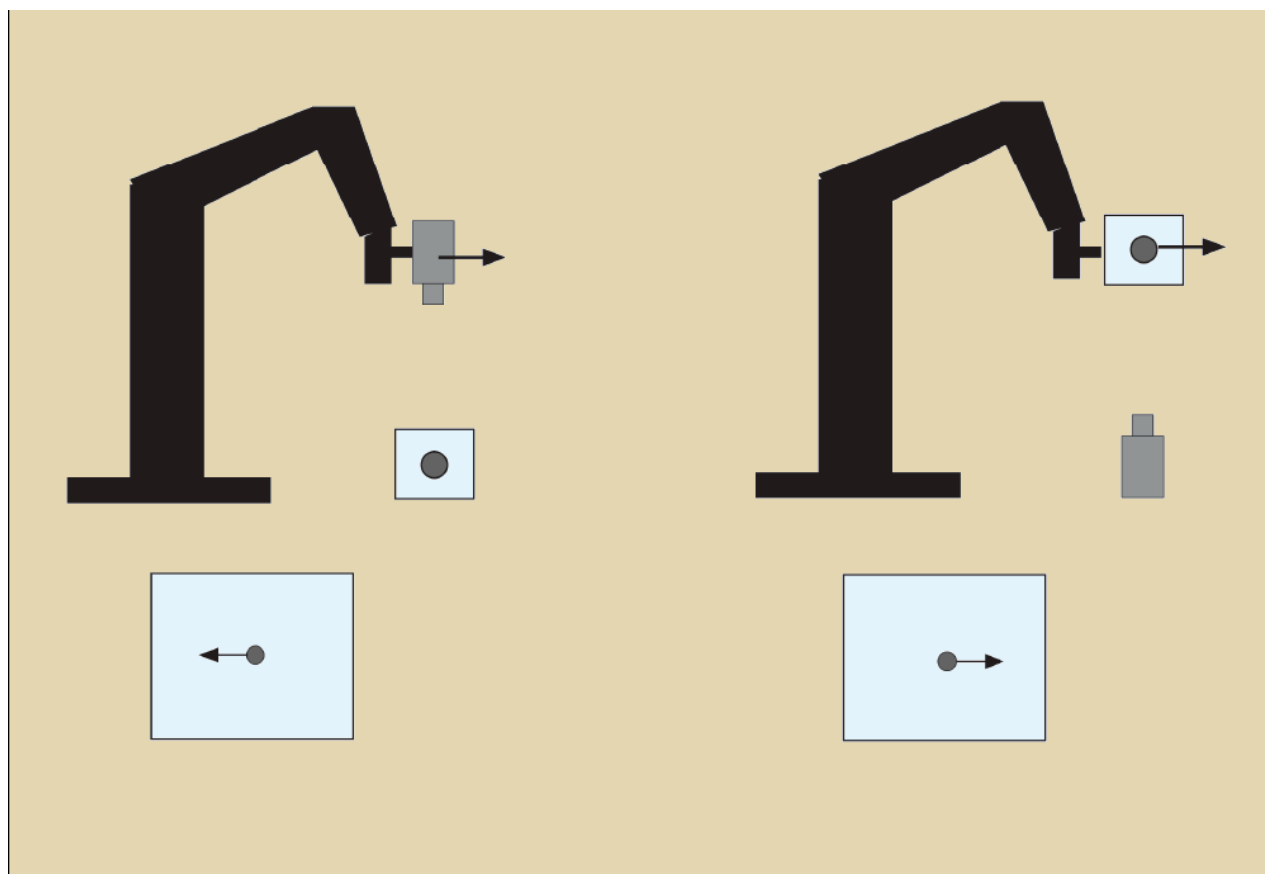

eye-in-hand

eye-to-hand

# Vision for assembly

---

video

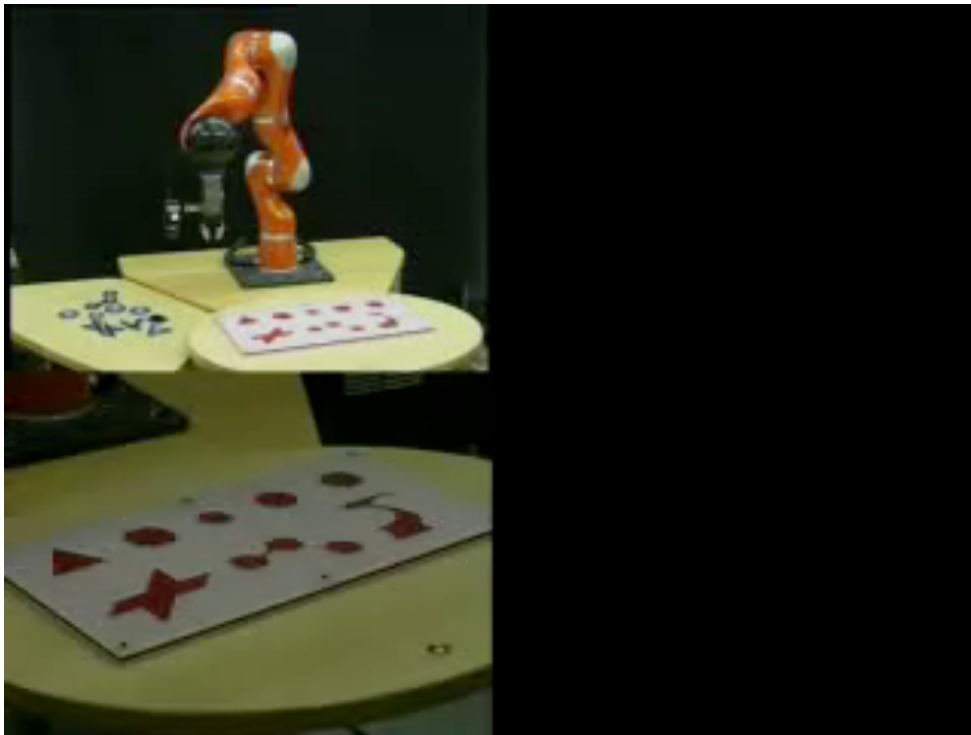

video



**PAPAS-DLR** system  
(eye-in-hand, **hybrid force-vision**)

robust w.r.t. motion of  
target objects

# Indirect/external visual servoing

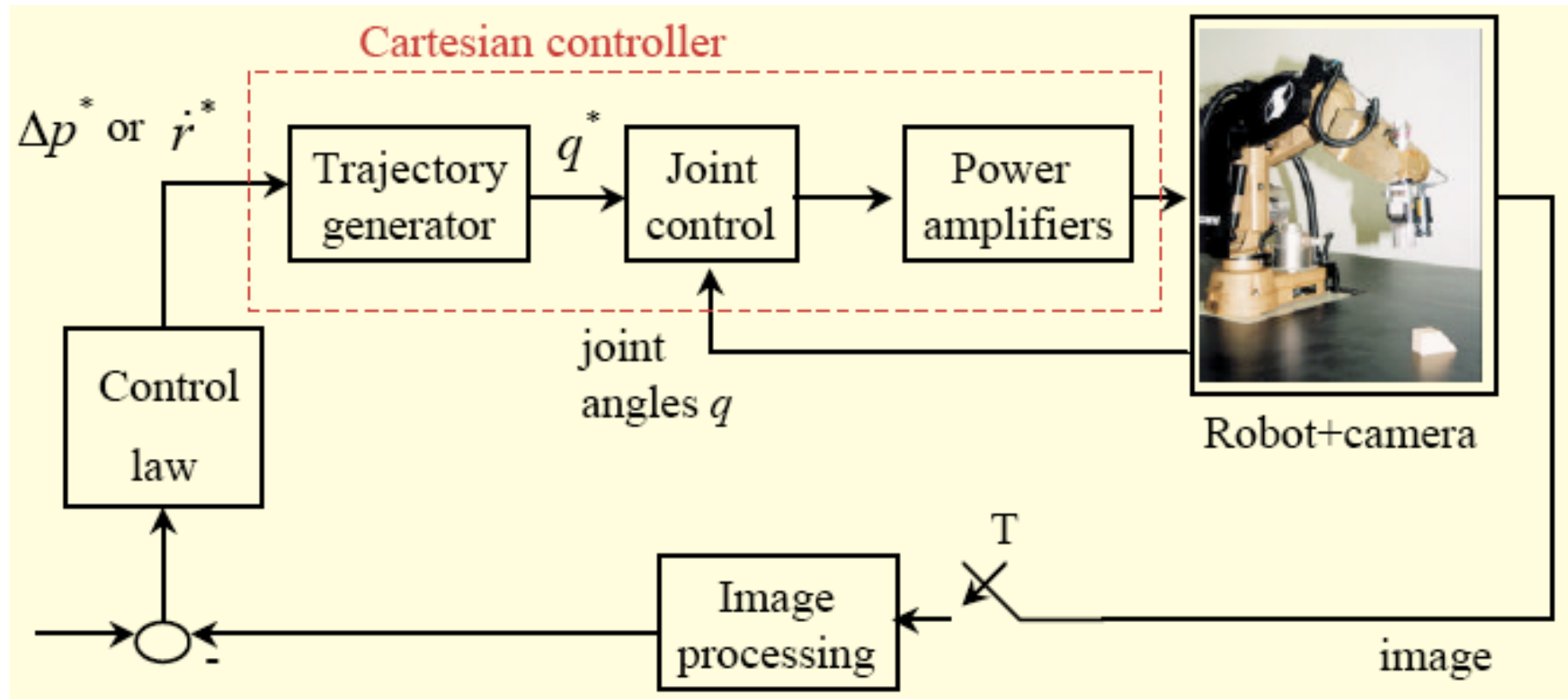

vision system provides set-point references to a Cartesian motion controller

- “easy” control law (same as without vision)
- appropriate for relatively slow situations (control sampling  $f = 1/T < 50\text{Hz}$ )



# Direct/internal visual servoing

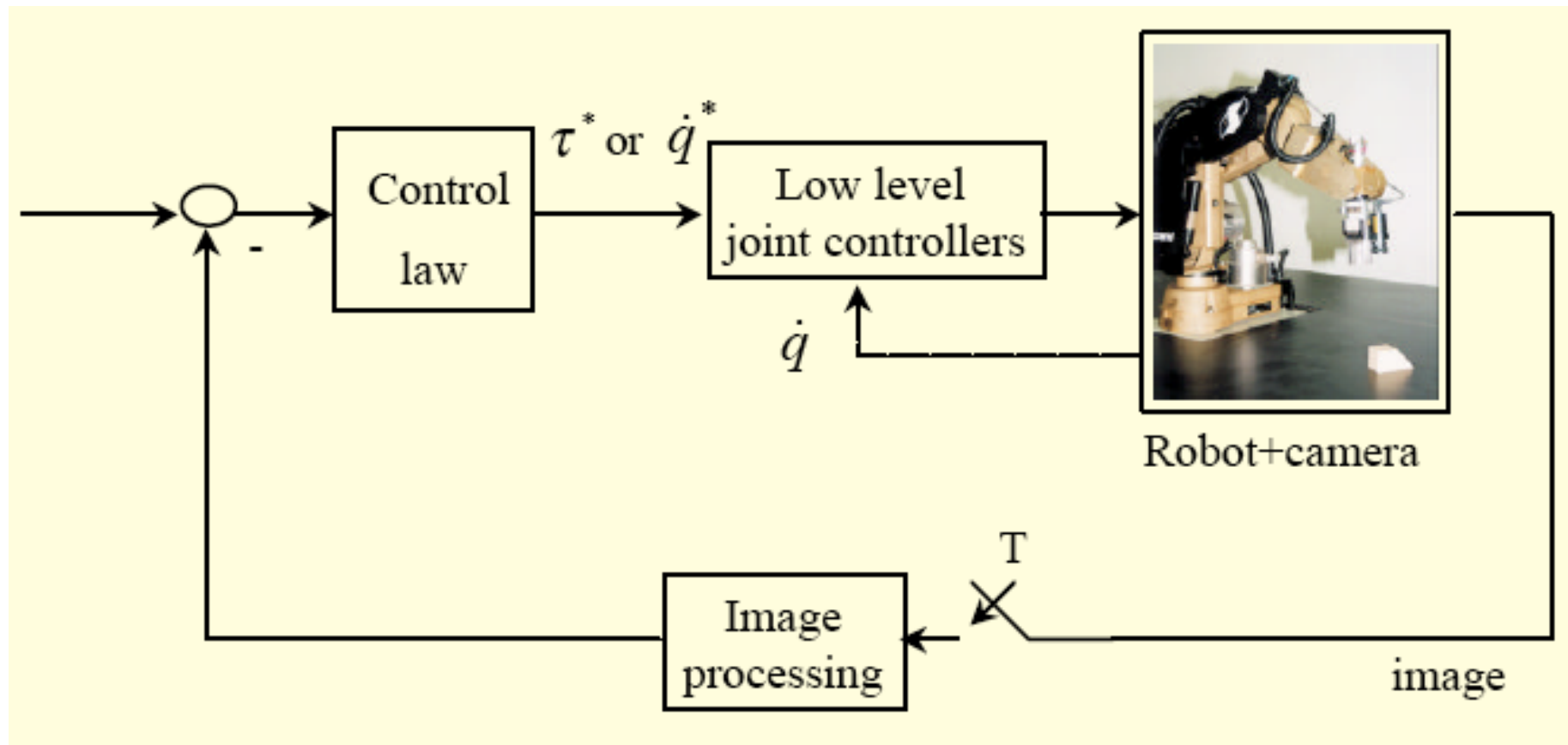

replace Cartesian controller with one based on vision that **directly computes joint reference commands**

- control law is more complex (involves robot kinematics/dynamics)
- preferred for fast situations (control sampling  $f = 1/T > 50\text{Hz}$ )

# Classification of visual servoing schemes

---



- **position-based** visual servoing (**PBVS**)
  - information extracted from images (**features**) is used to reconstruct the **current 3D pose** (pose/orientation) of an object
  - combined with the knowledge of a **desired 3D pose**, we generate a **Cartesian** pose error signal that drives the robot to the goal
- **image-based** visual servoing (**IBVS**)
  - error is computed directly on the values of the features extracted on the **2D image plane**, **without** going through a 3D reconstruction
  - the robot should move so as to bring the current image features (what it “sees” with the camera) to their desired values
- some mixed schemes are possible (e.g., **2½D methods**)



# Comparison between the two schemes

- position-based visual servoing (**PBVS**)

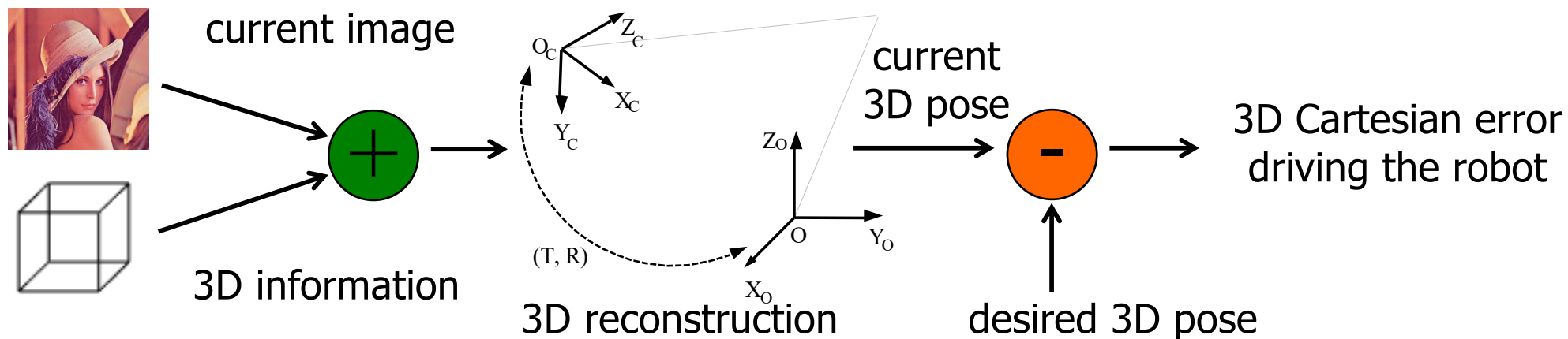

- image-based visual servoing (**IBVS**)

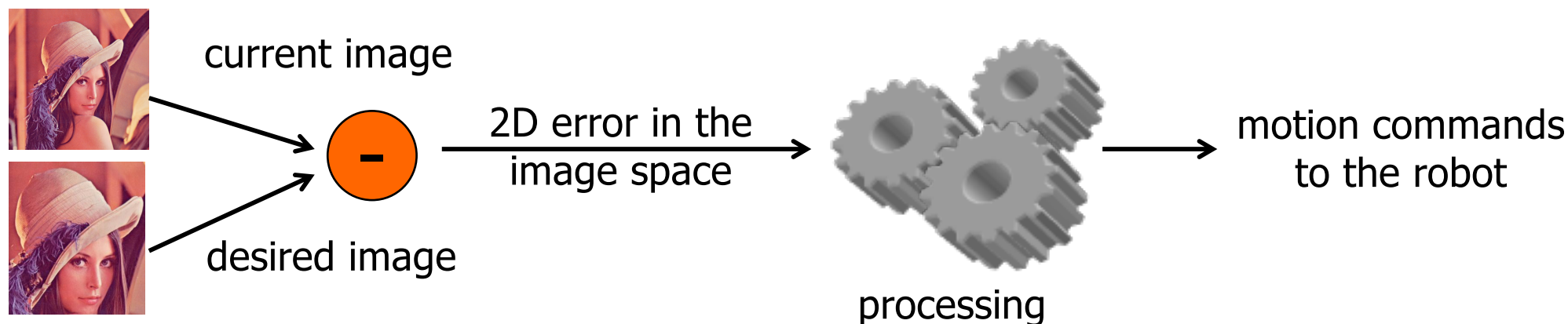



# PBVS architecture

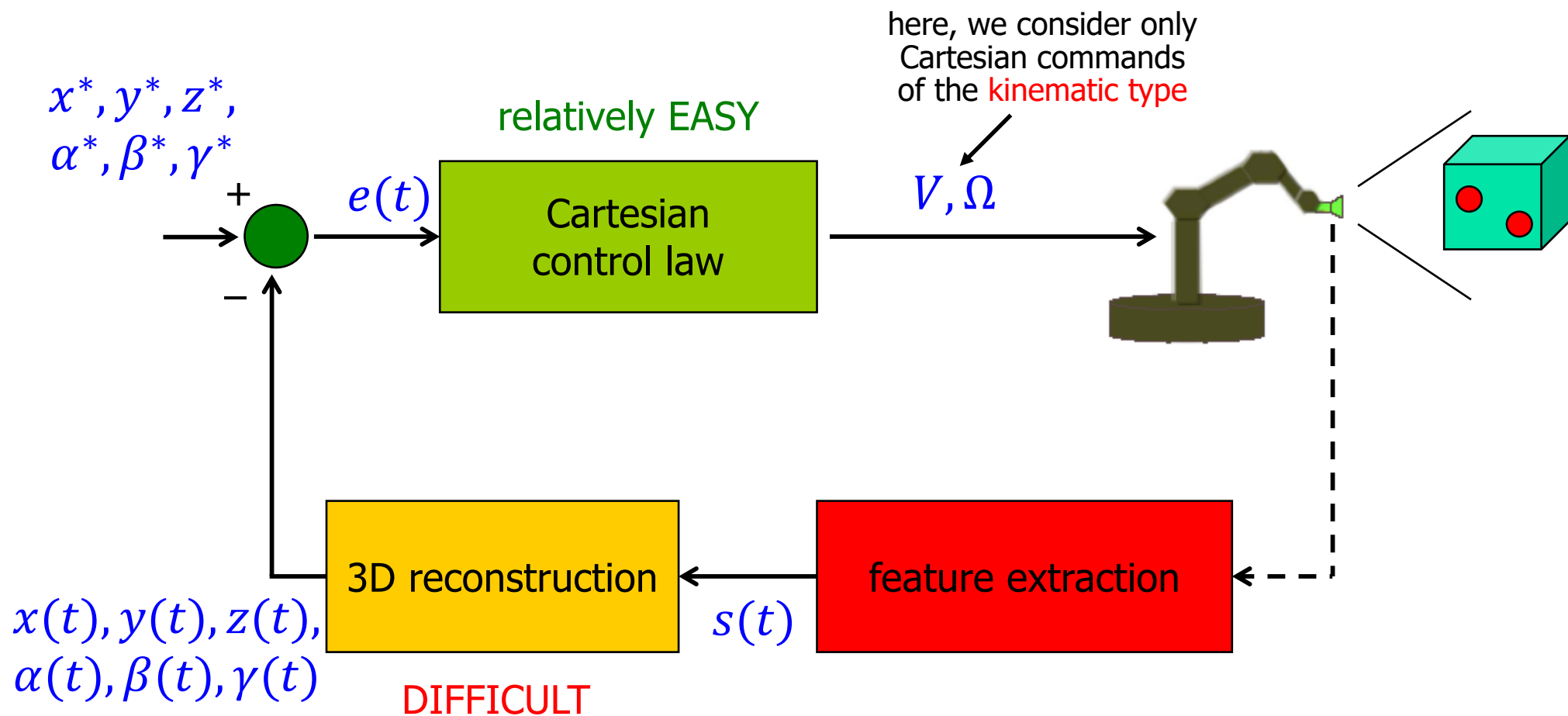

highly sensitive to camera calibration parameters

# Examples of PBVS

video

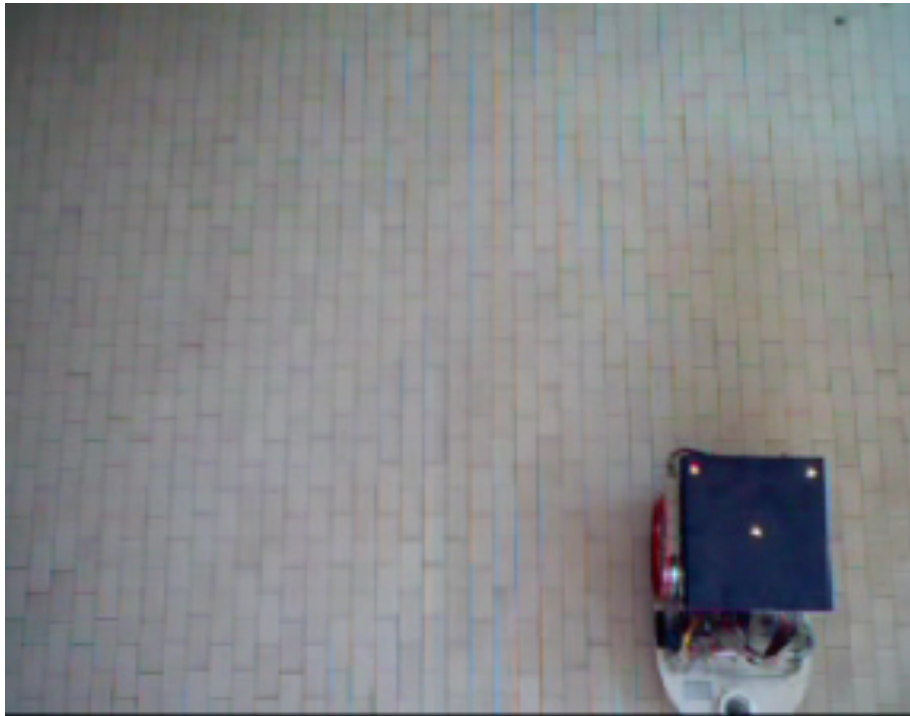

eye-to-“robot” (SuperMario)

position/orientation of the camera  
and scene geometry

known a priori!

video

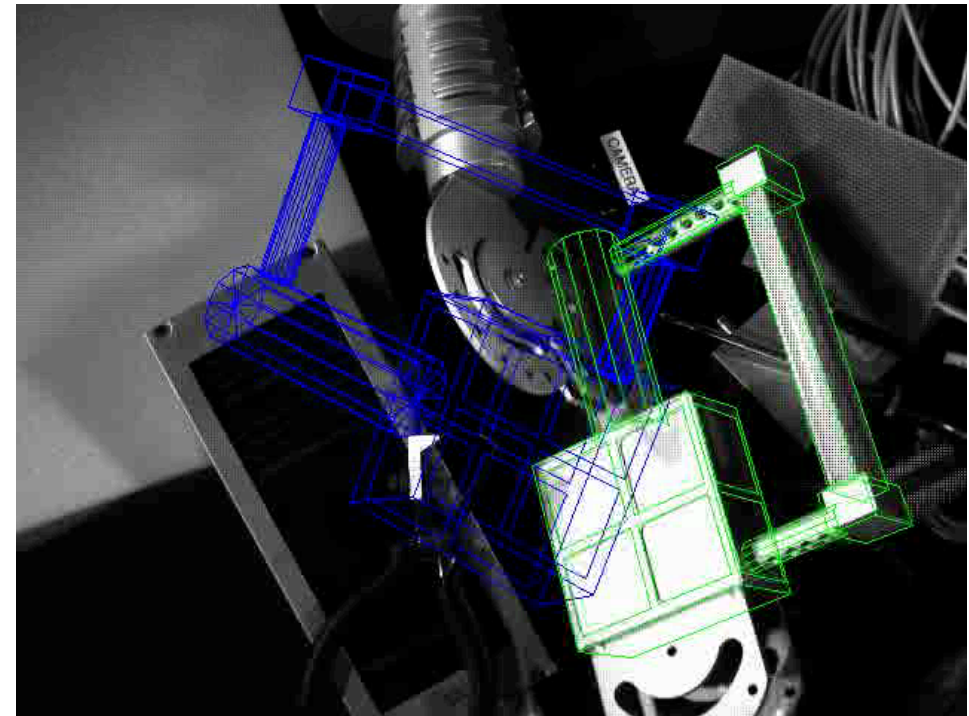

eye-in-hand (Puma robot)

position and orientation of the robot  
(with mobile or fixed base)

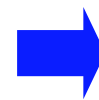



# IBVS architecture

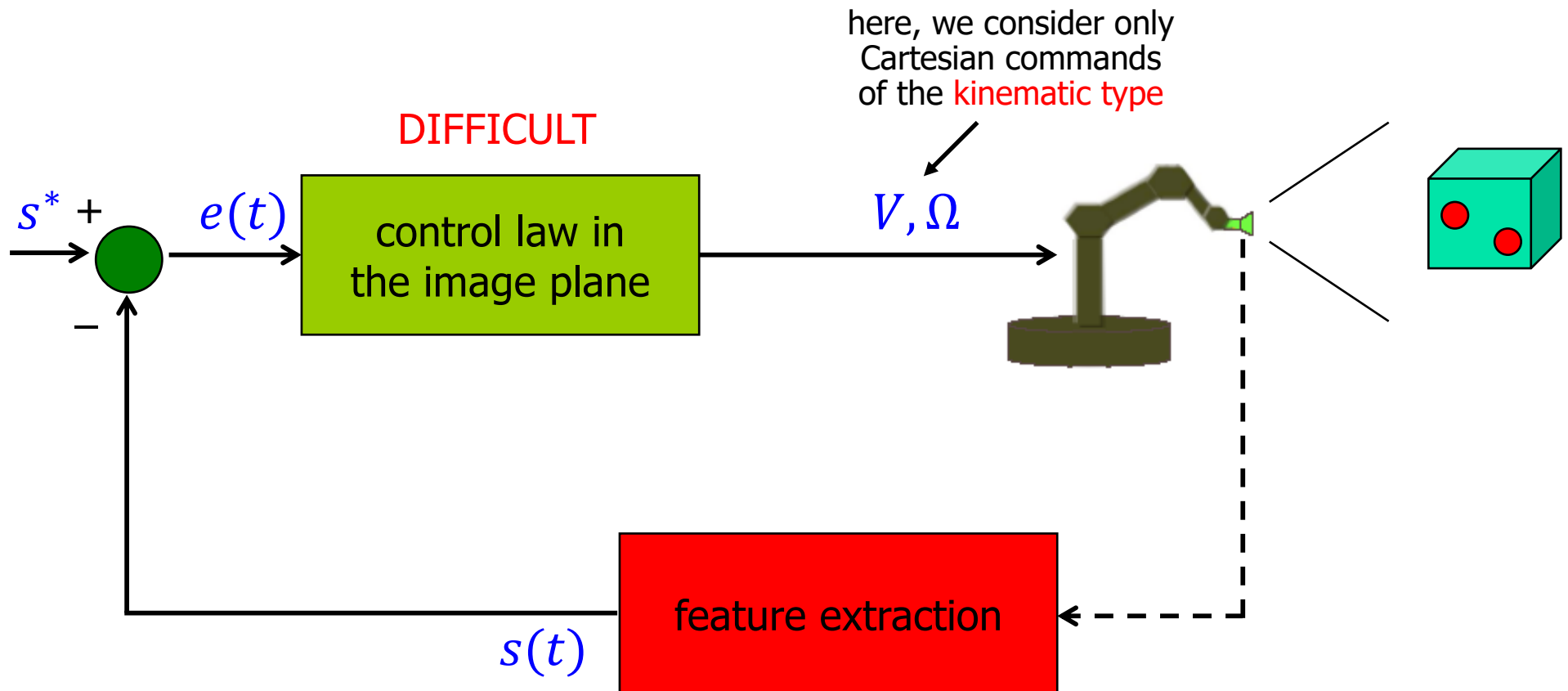

**almost insensitive** to intrinsic/extrinsic camera calibration parameters



# An example of IBVS

here, the features are **points** (selected from the given set, or in suitable combinations)

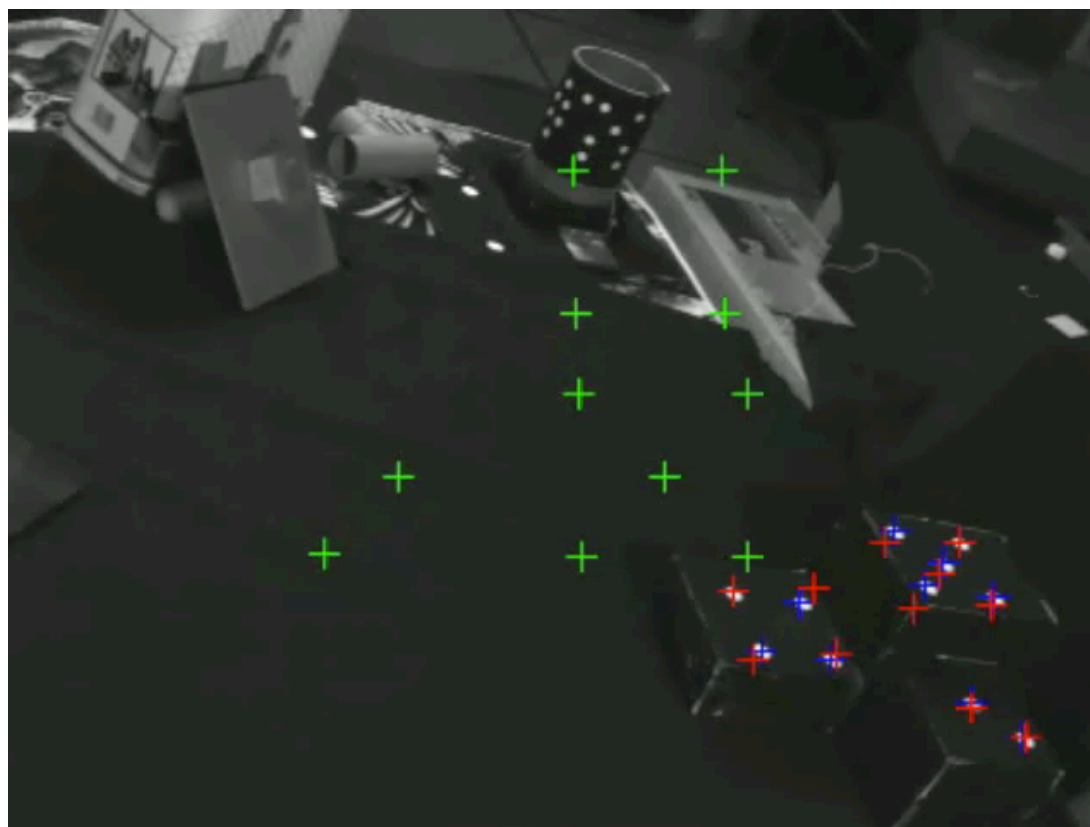

video

desired feature positions  
current feature positions



the error in the image plane (task space!) drives/controls the motion of the robot

# PBVS vs IBVS

PBVS = position-based  
visual servoing

IBVS = image-based  
visual servoing

video



video



F. Chaumette, INRIA Rennes

reconstructing the instantaneous  
(relative) 3D pose of the object

using (four) point features  
extracted from the 2D image

...and intermediate 2½-D visual servoing...





# Steps in an IBVS scheme

---

- **image acquisition**
  - frame rate, delay, noise, ...
- **feature extraction**
  - with image processing techniques (it could be a difficult and time consuming step!)
- **comparison** with “desired” feature values
  - definition of an **error** signal in the **image plane**
- **generation of motion of the camera/robot**
  - perspective transformations
  - differential kinematics of the manipulator
  - control laws of **kinematic** (most often) or **dynamic** type (e.g., PD + gravity cancelation --- **see reference textbook**)



# Image processing techniques

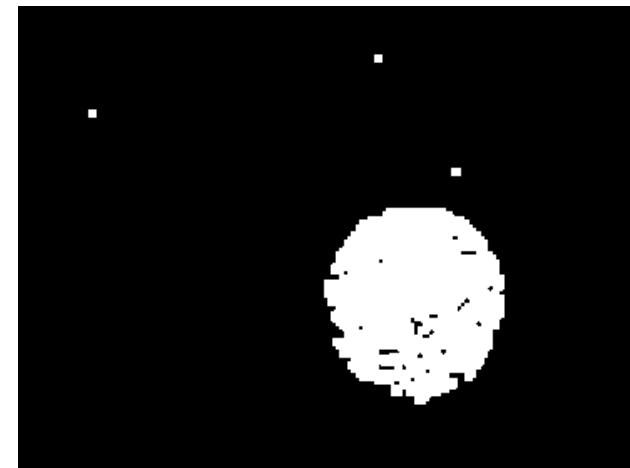
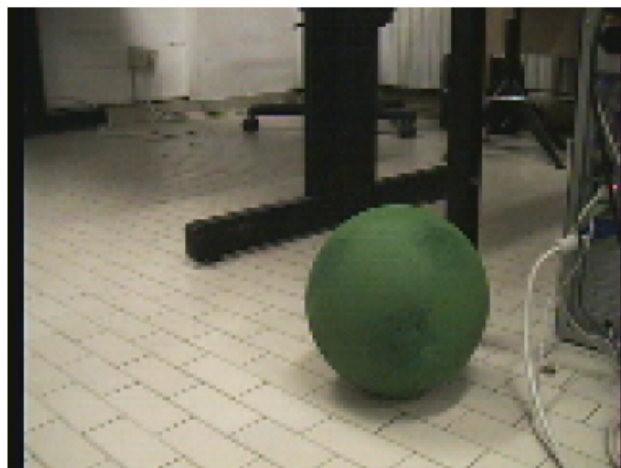

binarization in **RGB** space



erosion and dilation

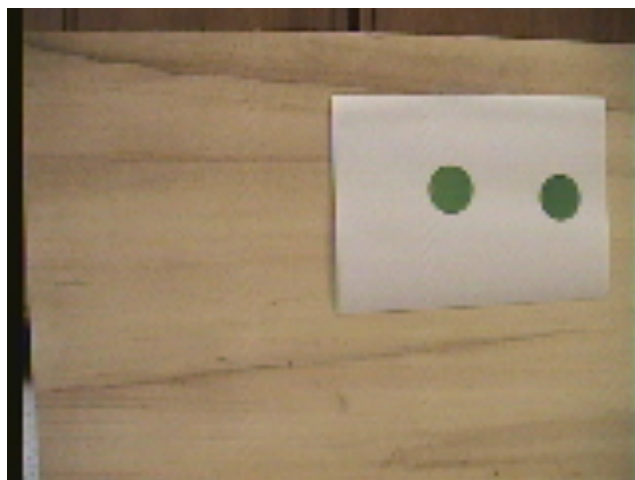

binarization in **HSV** space



dilation



# What is a feature?

---

- **image feature**: any interesting **characteristic** or **geometric structure** extracted from the image/scene
  - points
  - lines
  - ellipses (or any other 2D contour)
- **feature parameter(s)**: any **numerical quantity** associated to the selected feature in the image plane
  - coordinates of a point
  - angular coefficient and offset of a line
  - center and radius of a circle
  - area and center of a 2D contour
  - generalized **moments** of an object in the image
    - can also be defined so as to be scale- and rotation-invariant

# Example of IBVS using moments

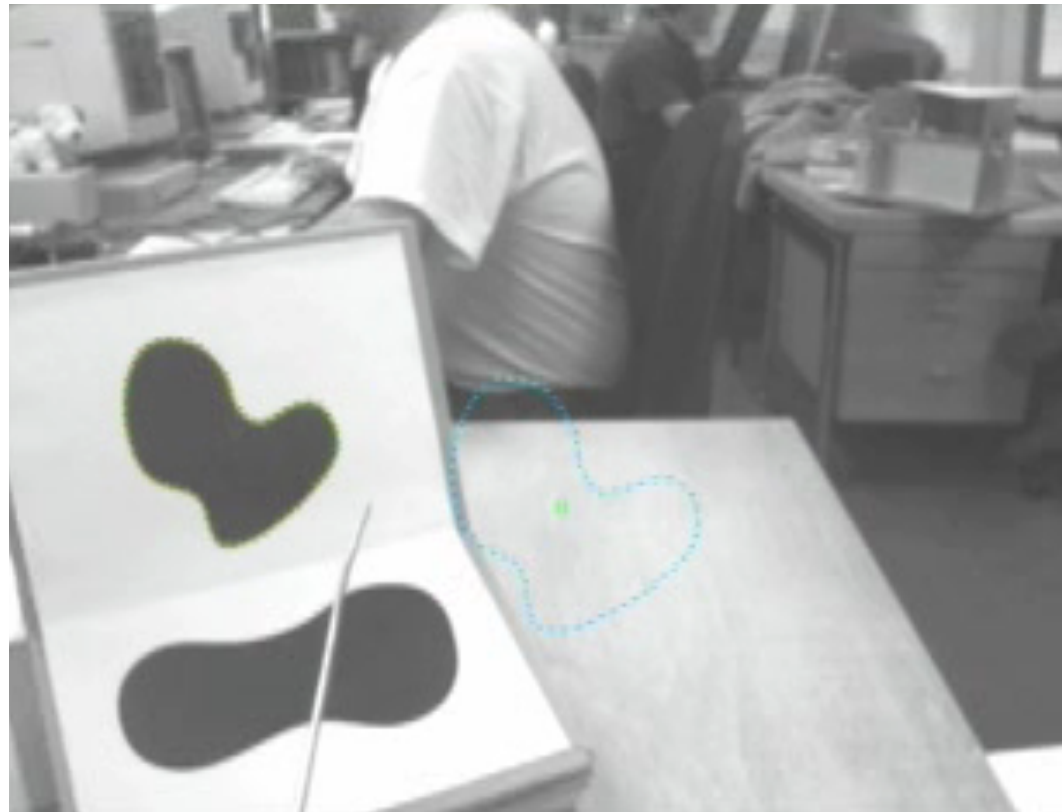

video

- avoids the problem of “finding **correspondences**” between points
- however, it is not easy to control the motion of all **6 dofs of the camera** when using only moments as features



# Camera model

---

- set of **lenses** to focus the incoming light
  - (converging) thin lenses
  - pinhole approximation
  - catadioptric lens or systems (combined with mirrors)
- matrix of light sensitive elements (pixels in **image plane**), possibly selective to **RGB** colors  $\sim$  human eye
- **frame grabber** “takes shots”: an electronic device that captures individual, digital still frames as output from an analog video signal or a digital video stream
  - board + software on PC
  - **frame rate** = output frequency of new digital frames
  - it is useful to randomly access a subset (area) of pixels



# Thin lens camera model

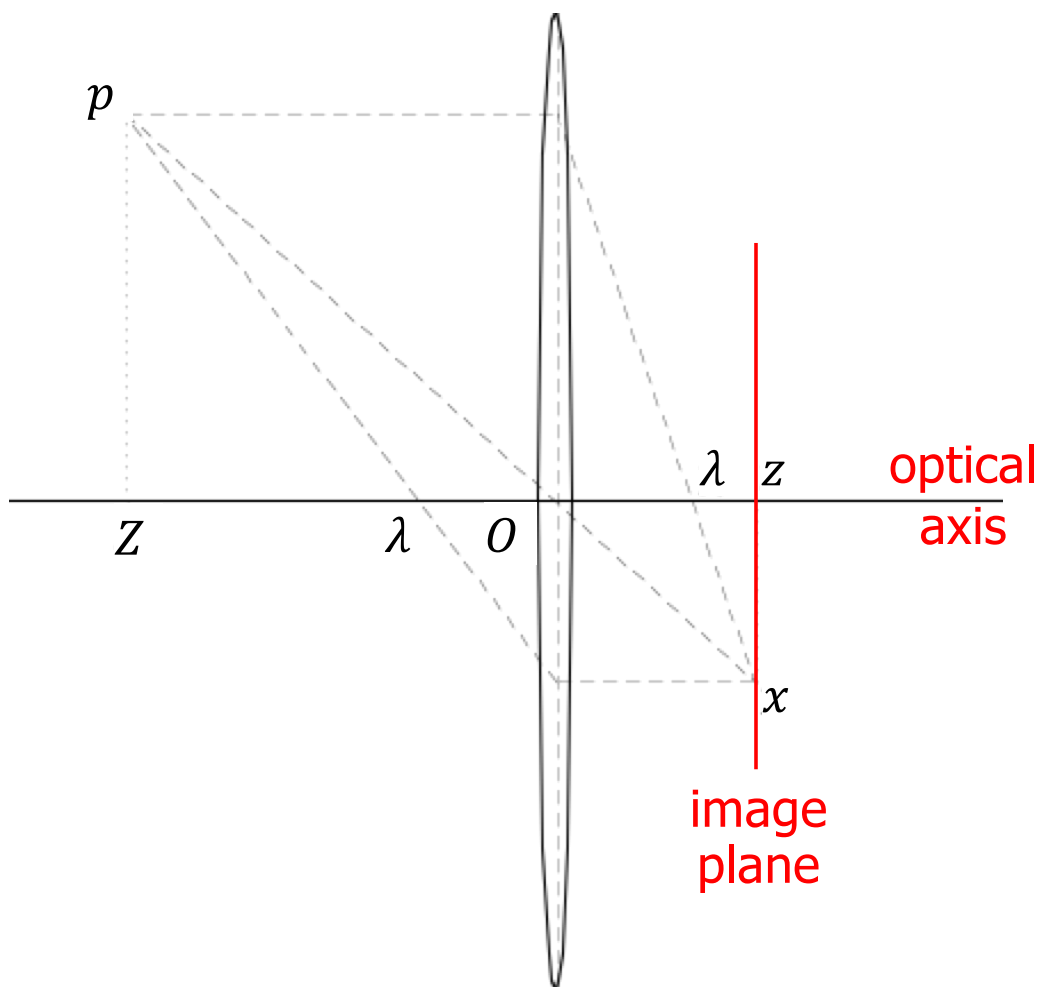

- geometric/projection optics
- rays parallel to the optical axis are deflected through a point at distance  $\lambda$  (focal length)
- rays passing through the optical center  $O$  are **not** deflected

fundamental equation  
of a thin lens

$$\left. \frac{1}{Z} + \frac{1}{z} = \frac{1}{\lambda} \right\} \text{dioptric (optical) power}$$

proof? left as exercise ...



# Pinhole camera model

- when thin lens wideness is neglected
- all rays pass through optical center
- from the relations on similar triangles one gets the **perspective equations**

$$u = \lambda \frac{X}{Z} \quad v = \lambda \frac{Y}{Z}$$

to obtain these from discrete pixel values, an **offset** and a **scaling factor** should be included in each direction

sometimes **normalized** values ( $u', v'$ ) are used (dividing by the focal length)

with

$$P = (X, Y, Z)$$

Cartesian point  
(in camera frame)

$$p = (u, v, \lambda)$$

representative point  
on the image plane

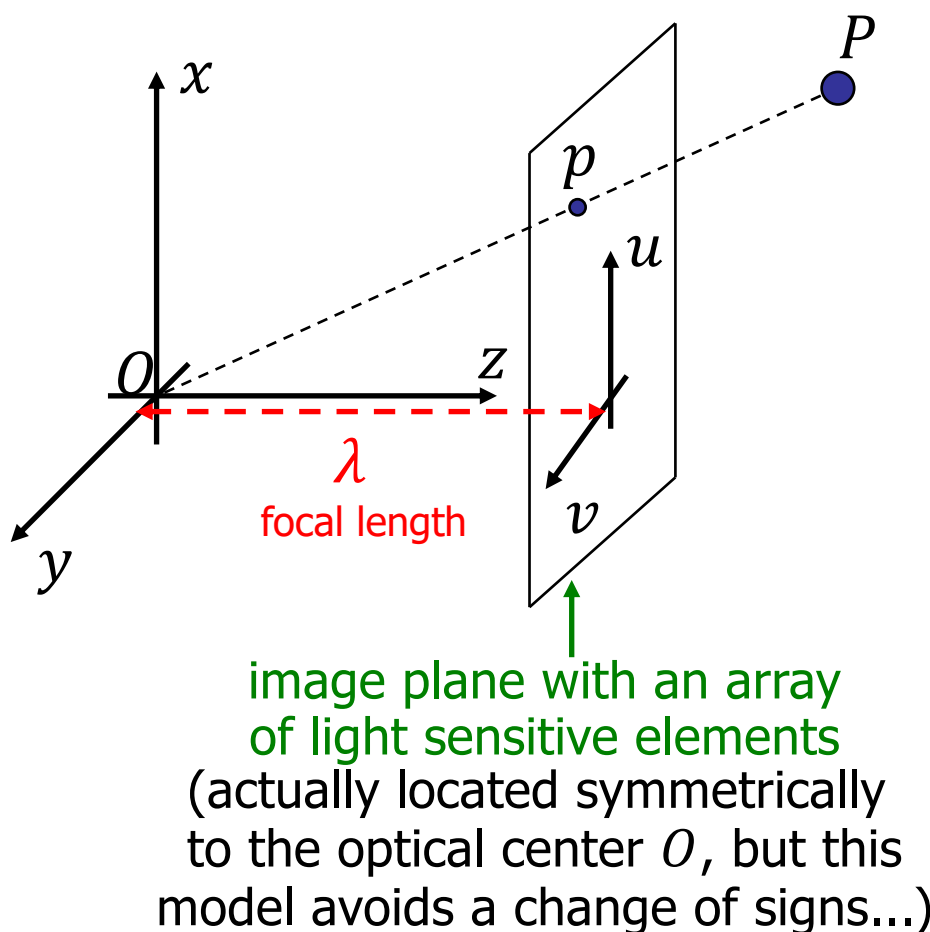



# Reference frames of interest

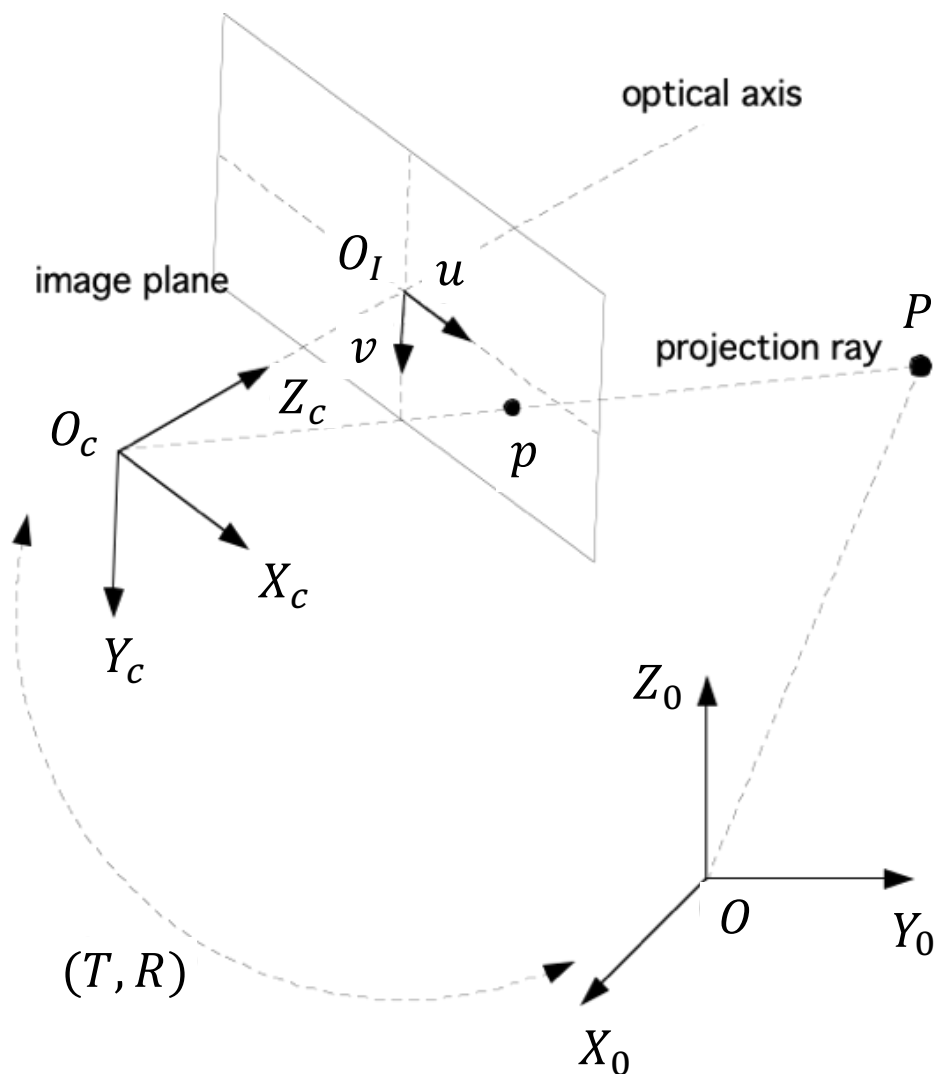

- absolute reference frame  
 $\mathcal{F}_0: \{O, \vec{X}_0, \vec{Y}_0, \vec{Z}_0\}$
- camera reference frame  
 $\mathcal{F}_c: \{O_c, \vec{X}_c, \vec{Y}_c, \vec{Z}_c\}$
- image plane reference frame  
 $\mathcal{F}_I: \{O_I, \vec{u}, \vec{v}\}$
- position/orientation of  $\mathcal{F}_c$   
w.r.t.  $\mathcal{F}_0$   
 $(T, R)$   
(translation, rotation)





# Interaction matrix

---

- given a set of feature(s) parameters  $f = [f_1 \ \cdots \ f_k]^T \in \mathbb{R}^k$
- we look for the **(kinematic) differential relation** between **motion imposed to the camera** and **motion of features** on the image plane

$$\dot{f} = J(\cdot) \begin{bmatrix} V \\ \Omega \end{bmatrix}$$

- $(V, \Omega) \in \mathbb{R}^6$  is the camera linear/angular velocity, a vector expressed in  $\mathcal{F}_c$
- $J(\cdot)$  is a  $k \times 6$  matrix, known as **interaction matrix**
- in the following, we consider mainly **point features**
  - other instances (areas, lines, ...) can be treated as extensions of the presented analysis



# Computing the interaction matrix

## point feature, pinhole model

- from the perspective equations  $u = \lambda \frac{X}{Z}$ ,  $v = \lambda \frac{Y}{Z}$ , we have

$$\begin{bmatrix} \dot{u} \\ \dot{v} \end{bmatrix} = \begin{bmatrix} \frac{\lambda}{Z} & 0 & -\frac{u}{Z} \\ 0 & \frac{\lambda}{Z} & -\frac{v}{Z} \end{bmatrix} \begin{bmatrix} \dot{X} \\ \dot{Y} \\ \dot{Z} \end{bmatrix} = J_1(u, v, \lambda) \begin{bmatrix} \dot{X} \\ \dot{Y} \\ \dot{Z} \end{bmatrix}$$

- the velocity  $(\dot{X}, \dot{Y}, \dot{Z})$  of a point  $P$  in frame  $\mathcal{F}_c$  is **actually due** to the roto-translation  $(V, \Omega)$  of the camera ( **$P$  is assumed fixed** in  $\mathcal{F}_0$ )
- kinematic relation between  $(\dot{X}, \dot{Y}, \dot{Z})$  and  $(V, \Omega)$

$$\begin{bmatrix} \dot{X} \\ \dot{Y} \\ \dot{Z} \end{bmatrix} = -V - \Omega \times \begin{bmatrix} X \\ Y \\ Z \end{bmatrix}$$

**Note:** ALL quantities are expressed in the camera frame  $\mathcal{F}_c$   
without explicit indication of subscripts

# Computing the interaction matrix (cont)

## point feature, pinhole model



- the last equation can be expressed in matrix form

$$\begin{bmatrix} \dot{X} \\ \dot{Y} \\ \dot{Z} \end{bmatrix} = \begin{bmatrix} -1 & 0 & 0 & 0 & -Z & Y \\ 0 & -1 & 0 & Z & 0 & -X \\ 0 & 0 & -1 & -Y & X & 0 \end{bmatrix} \begin{bmatrix} V \\ \Omega \end{bmatrix} = J_2(X, Y, Z) \begin{bmatrix} V \\ \Omega \end{bmatrix}$$

- combining things, the **interaction matrix** for a **point feature** is

$$\begin{bmatrix} \dot{u} \\ \dot{v} \end{bmatrix} = J_1 J_2 \begin{bmatrix} V \\ \Omega \end{bmatrix} = \begin{bmatrix} -\frac{\lambda}{Z} & 0 & \frac{u}{Z} & \frac{uv}{\lambda} & -\left(\lambda + \frac{u^2}{\lambda}\right) & v \\ 0 & -\frac{\lambda}{Z} & \frac{v}{Z} & \lambda + \frac{v^2}{\lambda} & -\frac{uv}{\lambda} & -u \end{bmatrix} \begin{bmatrix} V \\ \Omega \end{bmatrix}$$

$$= J_p(u, v, Z) \begin{bmatrix} V \\ \Omega \end{bmatrix}$$

↑  
 $p$  = point (feature)

here,  $\lambda$  is assumed to be known



# Comments

---

- the **interaction matrix** in the map

$$\begin{bmatrix} \dot{u} \\ \dot{v} \end{bmatrix} = \boxed{J_p(u, v, Z)} \begin{bmatrix} V \\ \Omega \end{bmatrix}$$

- depends on the actual value of the **feature** and on its **depth  $Z$**
- since  $\dim \ker J_p = 4$ , there exist  $\infty^4$  motions of the camera that are unobservable (for this feature) on the image
  - for instance, a translation along the projection ray
- when **more point features** are considered, the associated interaction matrices are stacked one on top of the other
  - $p$  point features: the interaction matrix is  $k \times 6$ , with  $k = 2p$



# Other examples of interaction matrices

- distance between two point features

$$d = \sqrt{(u_1 - u_2)^2 + (v_1 - v_2)^2}$$

$$\dot{d} = \frac{1}{d} \begin{bmatrix} u_1 - u_2 & v_1 - v_2 & u_2 - u_1 & v_2 - v_1 \end{bmatrix} \begin{bmatrix} \dot{u}_1 \\ \dot{v}_1 \\ \dot{u}_2 \\ \dot{v}_2 \end{bmatrix}$$

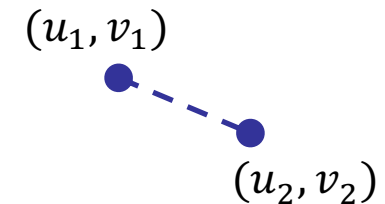

$$= J_p(u_1, u_2, v_1, v_2) \begin{bmatrix} J_{p1}(u_1, v_1, Z_1) \\ J_{p2}(u_2, v_2, Z_2) \end{bmatrix} \begin{bmatrix} V \\ \Omega \end{bmatrix}$$

- image moments

$$m_{ij} = \iint_{\mathcal{R}(t)} x^i y^j dx dy$$

$\mathcal{R}(t)$  region of the image plane occupied by the object

- useful for representing also qualitative geometric information (area, center, orientation of an approximating ellipse, ...)
- by using Green formulas and the interaction matrix of a generic point feature

$$\rightarrow \dot{m}_{ij} = L_{ij} \begin{bmatrix} V \\ \Omega \end{bmatrix}$$

(see F. Chaumette: "Image moments: A general and useful set of features for visual servoing", IEEE Trans. on Robotics, August 2004)



# IBVS with straight lines as features

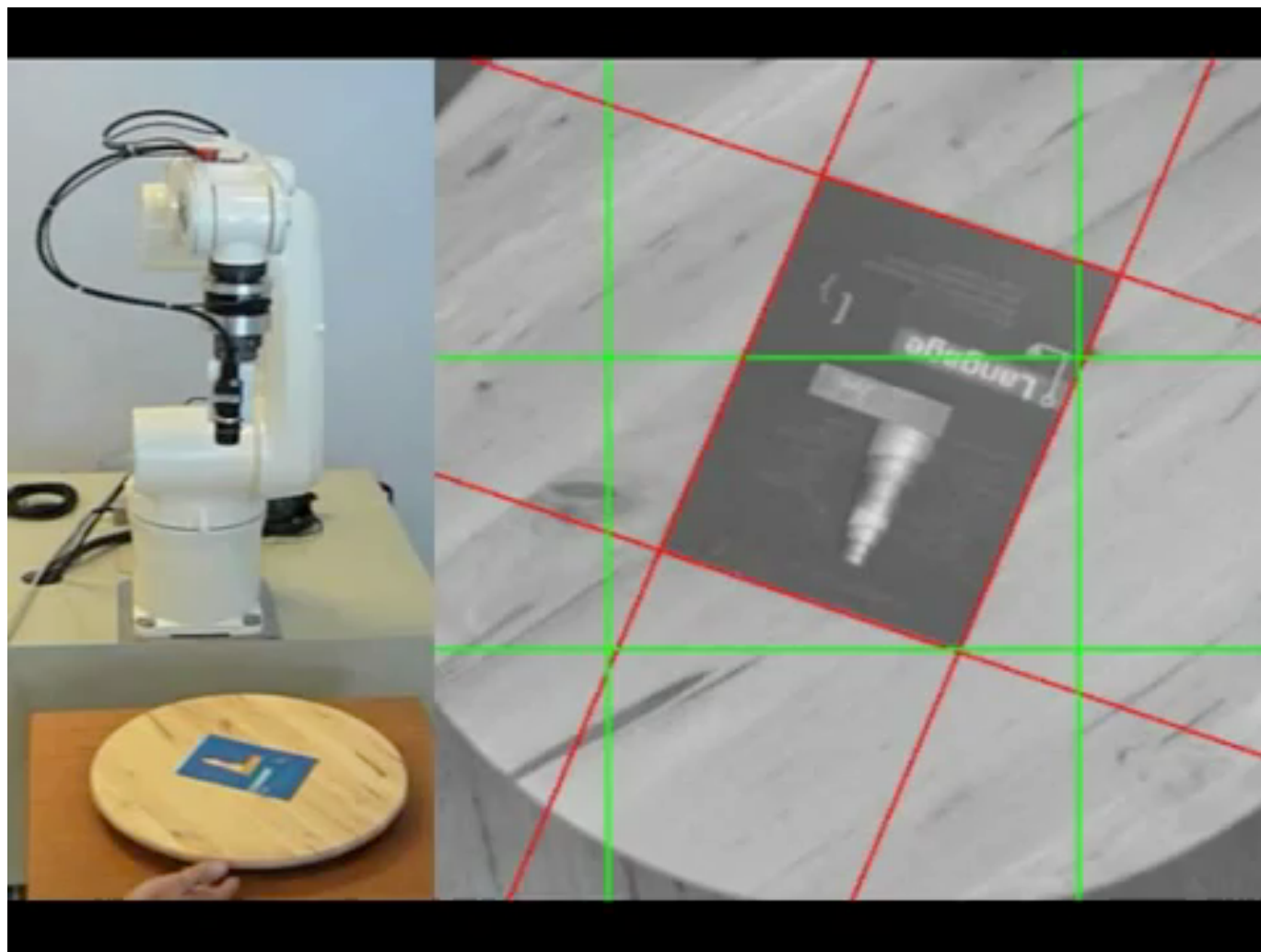

video

F. Chaumette, INRIA Rennes



# Robot differential kinematics

- **eye-in-hand** case: camera is mounted on the **end-effector** of a manipulator arm (with fixed base or on a wheeled mobile base)
- the motion  $(V, \Omega)$  to be imposed to the camera coincides with the desired **end-effector linear/angular velocity** and is realized by choosing the manipulator **joint velocity** (or, more in general, the feasible **velocity commands** of a **mobile** manipulator)

$$\begin{bmatrix} V \\ \Omega \end{bmatrix} = J_m(q) \dot{q} = J_m(q) u \quad \leftarrow \text{velocity control input}$$

for consistency with the previous interaction matrix, these Jacobians must be expressed in the camera frame  $\mathcal{F}_c$

$\left\{ \begin{array}{l} \text{Geometric Jacobian} \\ \text{of a manipulator} \end{array} \right.$       ... or the **NMM Jacobian** of a **mobile** manipulator

with  $q \in \mathbb{R}^n$  being the robot configuration variables

- in general, an **hand-eye calibration** is needed for this Jacobian



# Image Jacobian

---

- combining the step involved in the passage from the **velocity of point features** on the image plane to the **joint velocity/feasible velocity commands of the robot**, we finally obtain

$$\dot{f} = J_p(f, Z)J_m(q)u = J(f, Z, q)u$$

- matrix  $J(f, Z, q)$  is called the **Image Jacobian** and plays the same role of a classical robot Jacobian
- we can thus apply one of the many standard kinematic (or even dynamics-based) control techniques for robot motion
- the (controlled) **output** is given by the vector of features in the image plane (the **task space!**)
- the **error** driving the control law is defined in this task space





# Kinematic control for IBVS

- defining the error vector as  $e = f_d - f$ , the general choice

$$u = J^\#(\dot{f}_d + ke) + (I - J^\#J)u_0$$



minimum norm solution



term in  $\ker J$  does not "move" the features

will exponentially stabilize the task error to zero (up to singularities, limit joint range/field of view, features exiting the image plane, ...)

- in the redundant case, vector  $u_0$  (projected in the image Jacobian null space) can be used for optimizing behavior/criteria
- the error feedback signal depends only on feature values
- there is still a dependence of  $J$  on the depths  $Z$  of the features
  - use the constant and "known" values at the final desired pose

$$J(f, Z^*, q)$$

- or, estimate on line their current values using a dynamic observer



# Example with NMM

- mobile base (unicycle) + 3R manipulator
- eye-in-hand configuration



- 5 commands
  - linear and angular velocity of mobile base
  - velocities of the three manipulator joints
- task specified by 2 point features  $\longrightarrow$  4 output variables

$$f = [f_{u1} \quad f_{v1} \quad f_{u2} \quad f_{v2}]^T$$

- $5 - 4 = 1$  degree of redundancy (w.r.t. the task)

# Simulation

view from camera

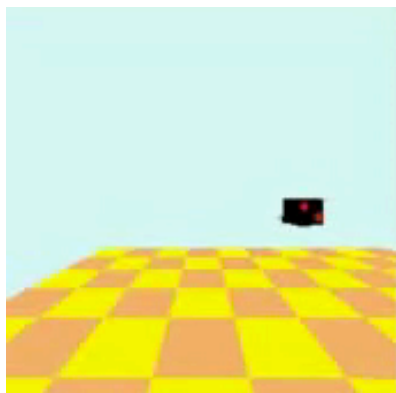

processed image

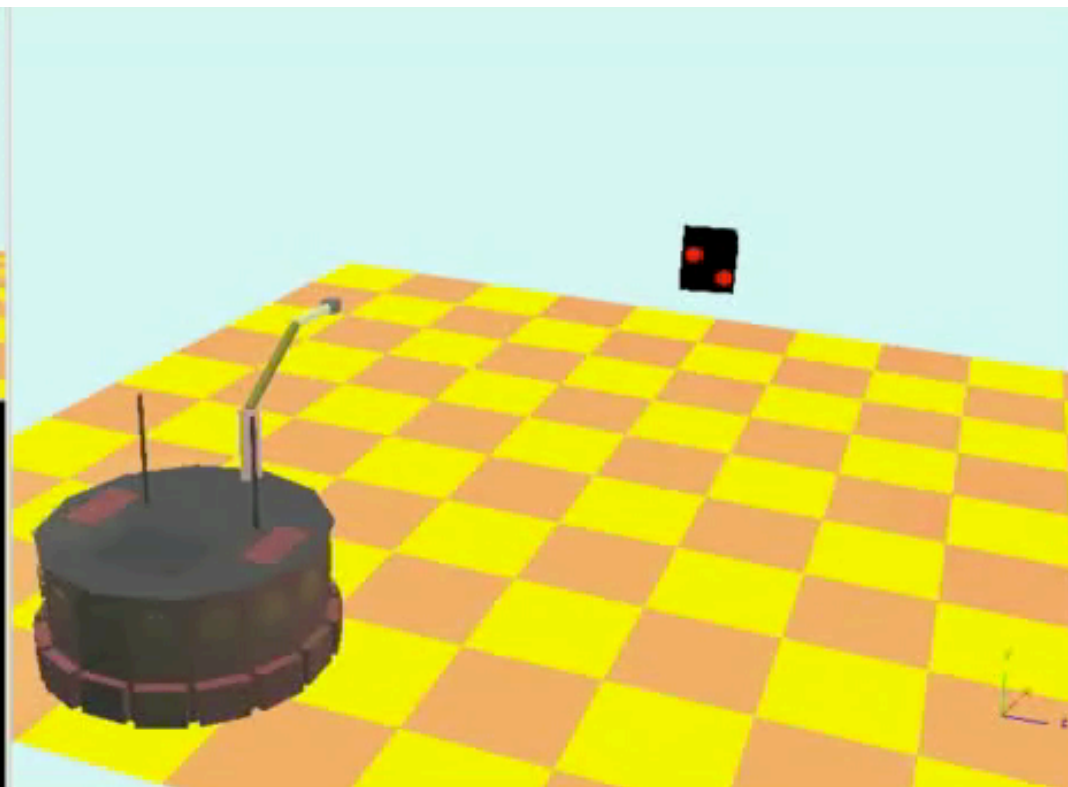

video

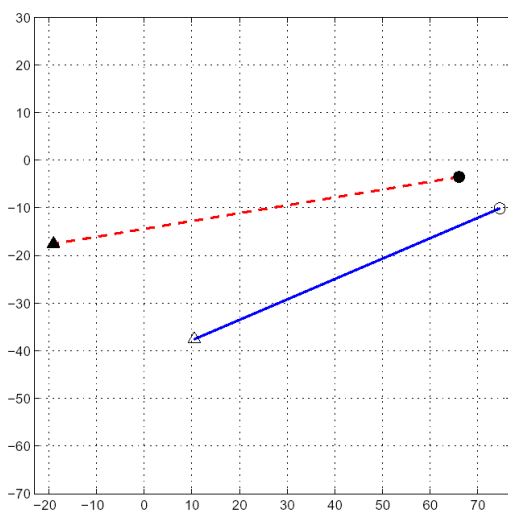

behavior of the 2 features

- simulation in Webots
- current value of  $Z$  is supposed to be known
- diagonal task gain matrix  $k$  (decoupling!)
- "linear paths" of features motion on the image plane



# IBVS control with Task Sequencing

- approach: **regulate only one (some) feature** at the time, while keeping “**fixed**” the others by **unobservable motions** in the image plane

- Image Jacobians of single point features (e.g.,  $p = 2$ )

$$\dot{f}_1 = J_1 u, \quad \dot{f}_2 = J_2 u$$

- the first feature  $f_1$  is regulated during a first phase by using

$$u = J_1^\# k_1 e_1 + (I - J_1^\# J_1) u_0$$

- feature  $f_2$  is then regulated by a command in the null-space of the first task

$$u = (I - J_1^\# J_1) J_2^T k_2 e_2$$

- in the first phase there are **two (more) degrees of redundancy** w.r.t. the “**complete**” case, which can be used, e.g., for improving robot alignment to the target
- if the complete case is **not** redundant: singularities are typically met without Task Sequencing, but possibly prevented with TS ...

# Simulation with TS scheme

mobile base (unicycle) + polar 2R arm: Image Jacobian is square ( $4 \times 4$ )

point feature 1  
(regulated in  
first phase)  
point feature 2  
(in second phase)

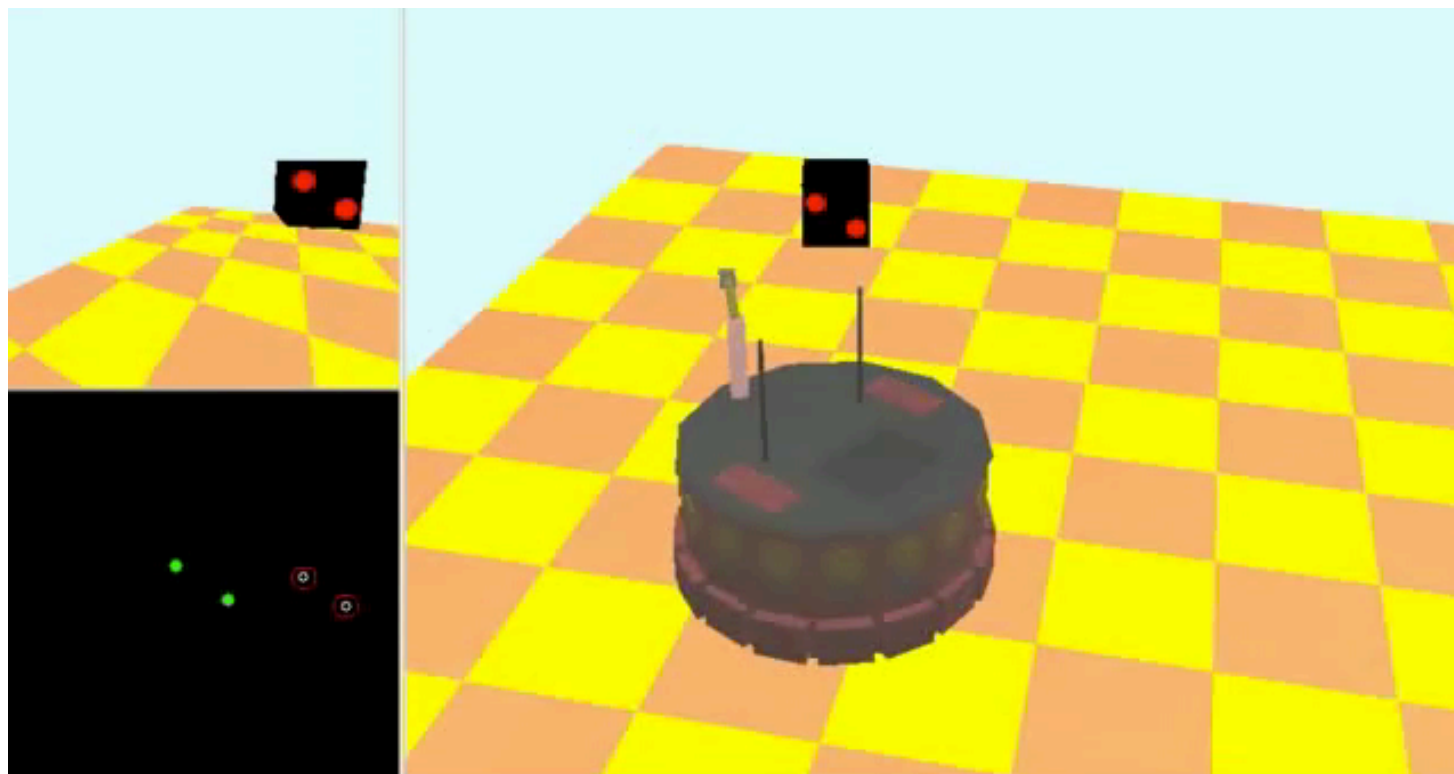
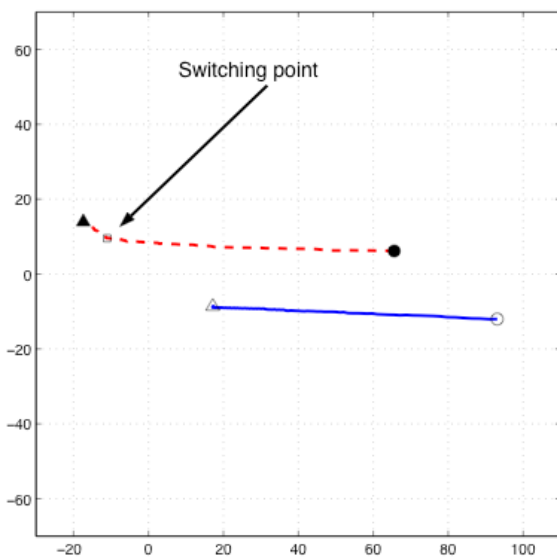

video

behavior of  
the 2 features

- simulation in Webots
- current value of  $Z$  is supposed to be known

# Experiments

Magellan (unicycle) + pan-tilt camera (same mobility of a polar 2R robot)



Video attachment to ICRA'08 paper

Visual Servoing with Exploitation of Redundancy:  
An Experimental Study

A. De Luca    M. Ferri    G. Oriolo    P. Robuffo Giordano

Dipartimento di Informatica e Sistemistica  
Università di Roma "La Sapienza"

video

- comparison between **Task Priority (TP)** and **Task Sequencing (TS)** schemes
- both can handle singularities (of Image Jacobian) that are possibly encountered
- camera frame rate = 7 Hz



# In many practical cases...

- the uncertainty in a number of relevant data may be large
  - focal length  $\lambda$  (**intrinsic** camera parameters)
  - **hand-eye calibration** (**extrinsic** camera parameters)
  - **depth**  $Z$  of point features
  - ....
- one can only compute an **approximation** of the Image Jacobian (both in its **interaction matrix** part, as well as in the **robot Jacobian** part)
- in the closed loop, error dynamics on features becomes
$$\dot{e} = -J \hat{J}^{\#} K e$$
  - **ideal** case:  $J J^{\#} = I$       **real** case:  $J \hat{J}^{\#} \neq I$
- it is possible to show that a **sufficient condition** for **local** convergence of the error to zero is

$$J \hat{J}^{\#} > 0$$

# Approximate Image Jacobian

- use a constant Image Jacobian  $\hat{J}(Z^*)$  that is computed at the desired target  $s^*$  (with a **known, fixed** depth  $Z^*$ )

$$\dot{q} = J^\#(Z)Ke$$

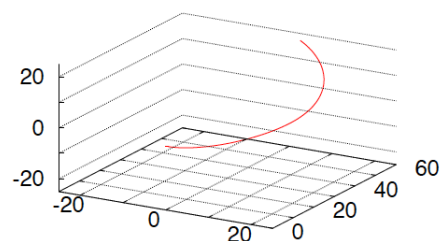
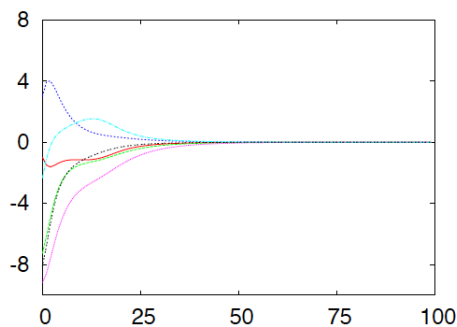

video

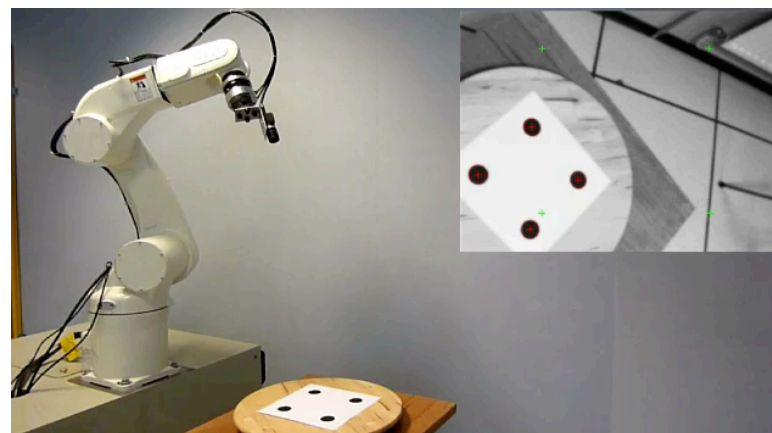

F. Chaumette, INRIA Rennes

$$\dot{q} = \hat{J}^\#(Z^*)Ke$$

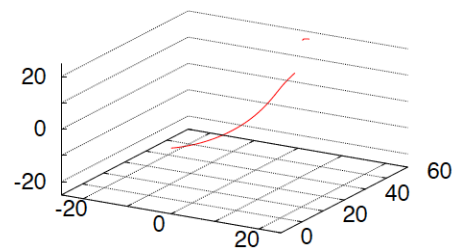
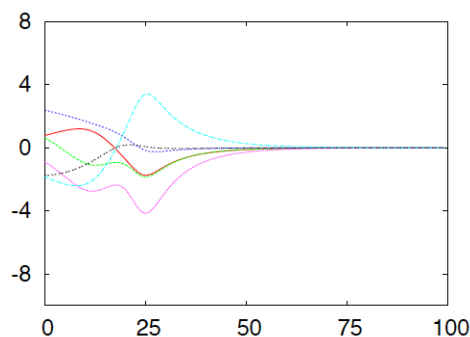

video

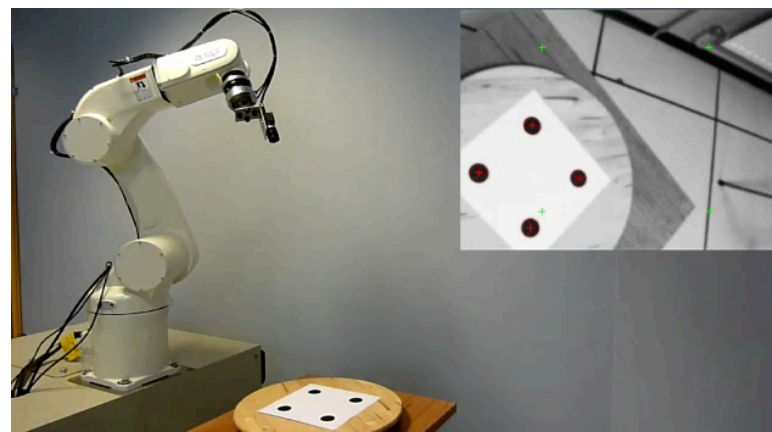





# An observer of the depth $Z$

- it is possible to **estimate on line** the current value (possibly time-varying) of the depth  $Z$ , **for each** considered point feature, using a dynamic **observer**
- define  $x = [u \quad v \quad 1/Z]^T$ ,  $\hat{x} = [\hat{u} \quad \hat{v} \quad 1/\hat{Z}]^T$  as **current state** and **estimated state**, and  $y = [u \quad v]^T$  as **measured output**
- a (nonlinear) observer of  $x$  with input  $u_c = [V \quad \Omega]^T$

$$\dot{\hat{x}} = \alpha(\hat{x}, y)u_c + \beta(\hat{x}, y, u_c)$$

guarantees  $\lim_{t \rightarrow \infty} \|x(t) - \hat{x}(t)\| = 0$  **provided that**

- **linear velocity** of the camera is **not** zero
  - the linear velocity vector **is not aligned** with the projection ray of the considered point feature
- ⇒ these are **persistent excitation** conditions ( $\sim$  observability conditions)



# Block diagram of the observer

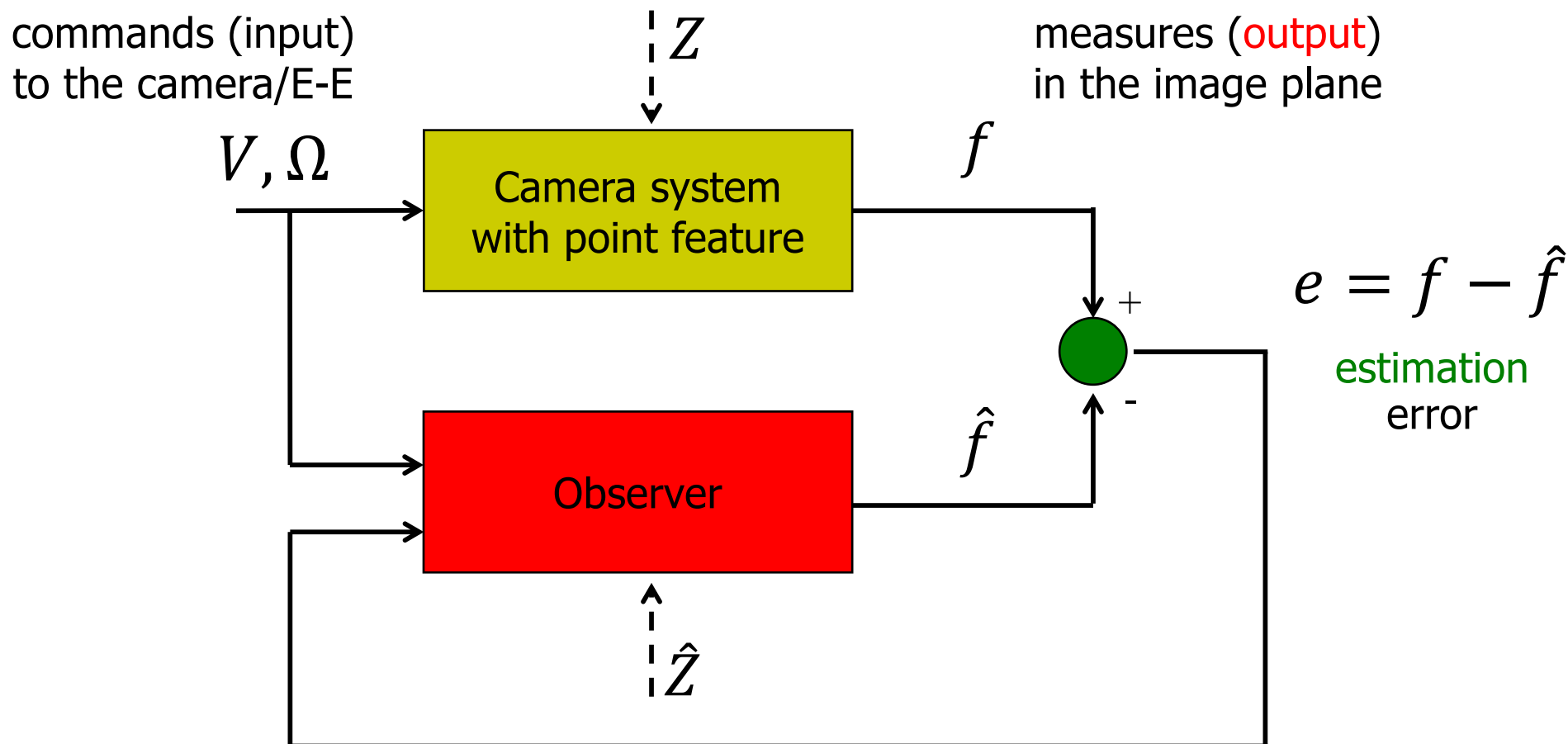



# Results on the estimation of $Z$

real and estimated initial state

$$x(t_0) = [10 \quad -10 \quad 2]^T$$
$$\hat{x}(t_0) = [10 \quad -10 \quad 1]^T$$

$$v_x(t) = 0.1 \cos 2\pi t$$
$$v_z(t) = 0.5 \cos \pi t$$
$$\omega_x(t) = 0.6 \cos(\pi/2)t$$
$$\omega_z(t) = 1$$

open-loop  
commands

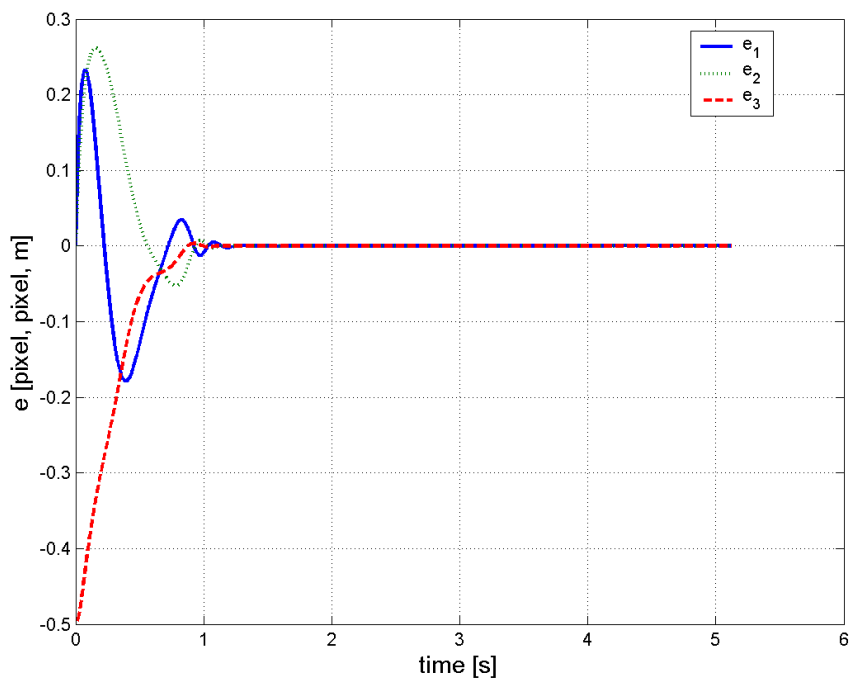

estimation errors  $e(t)$

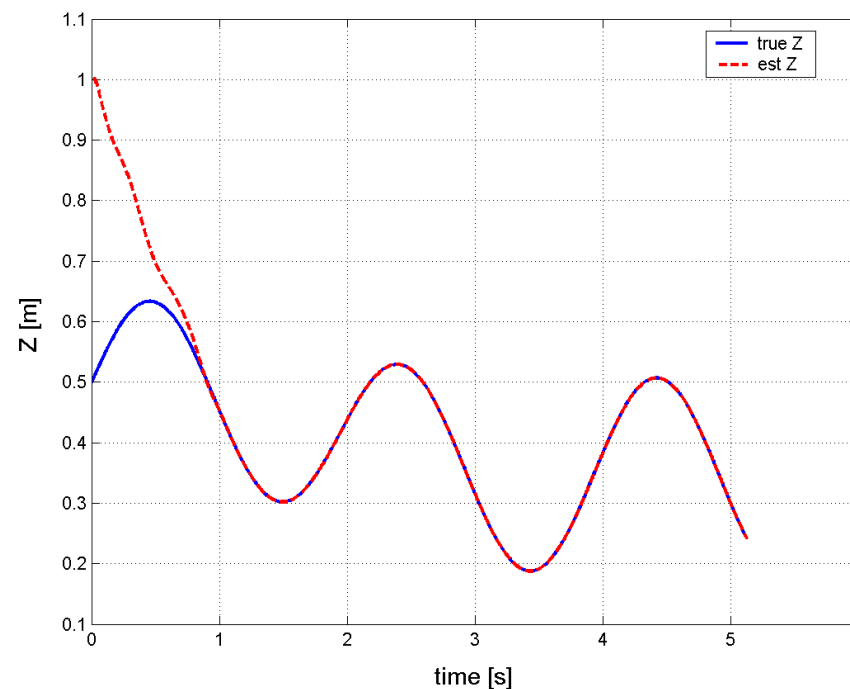

$Z(t)$  and  $\hat{Z}(t)$



# Simulation of the observer with stepwise displacements of the target

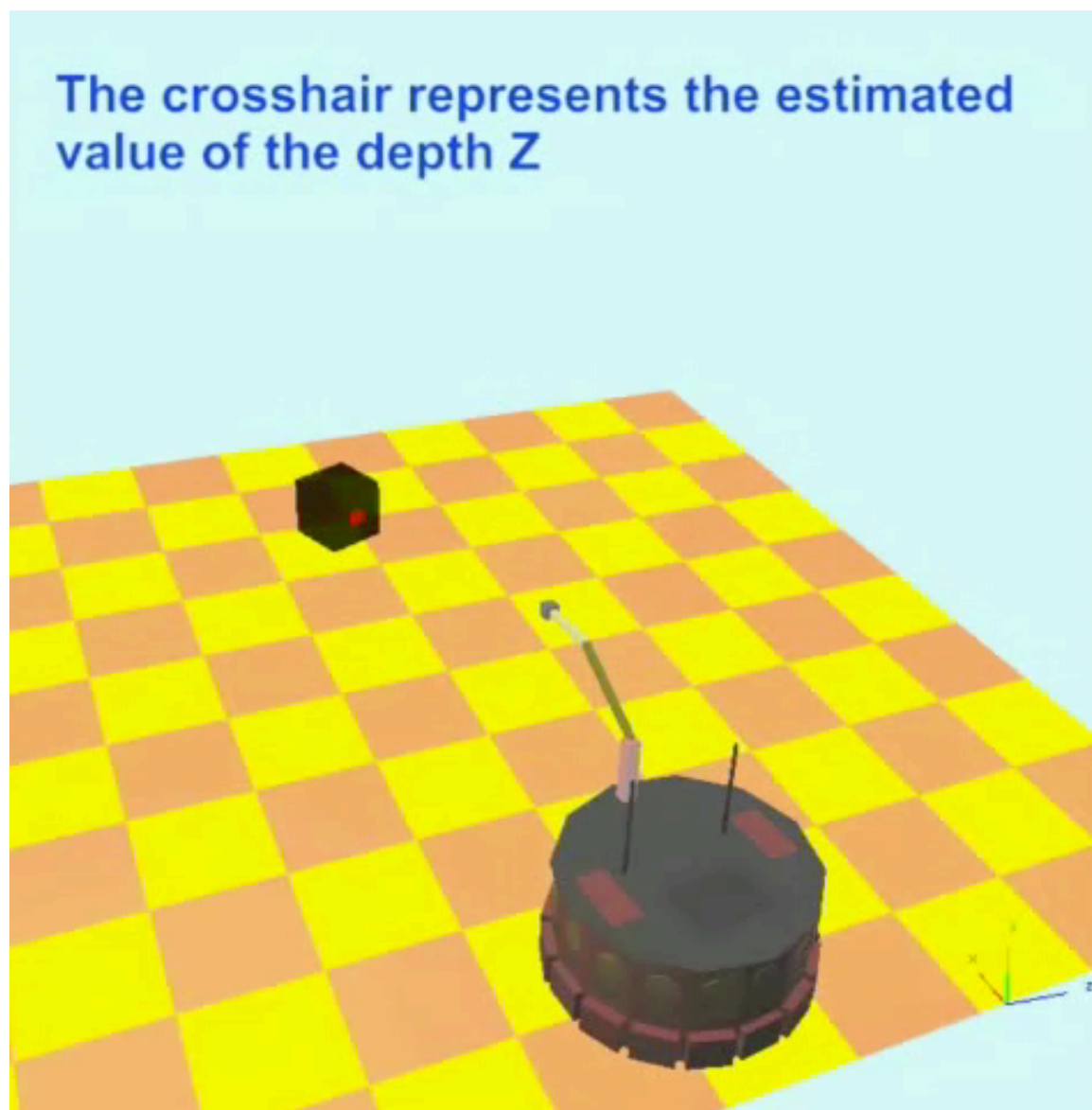

video



# IBVS control with observer

- the depth observer can be easily **integrated on line** with any IBVS control scheme

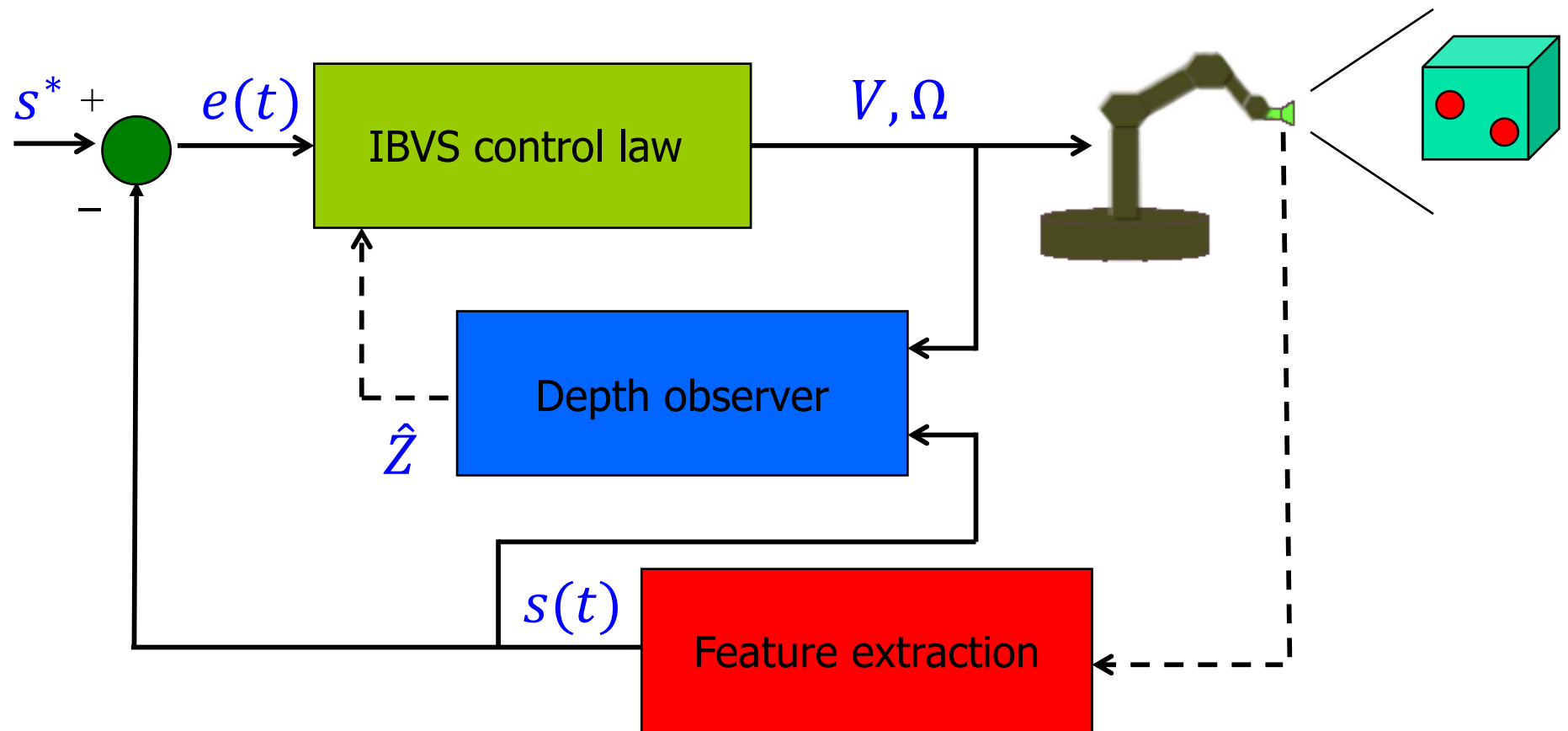

# Experimental set-up

- visual servoing with fixed camera on a skid-steering mobile robot
- **very rough** eye-robot calibration
- **unknown** depths of target points (**estimated on line**)



a "virtual" 5<sup>th</sup> feature is also used  
as the **average** of the four point features

# Experiments

- motion of features on the image plane is not perfect...
- the visual **regulation** task is however correctly **realized**

external view

camera view



video (c/o Università di Siena)

# Evolution of features

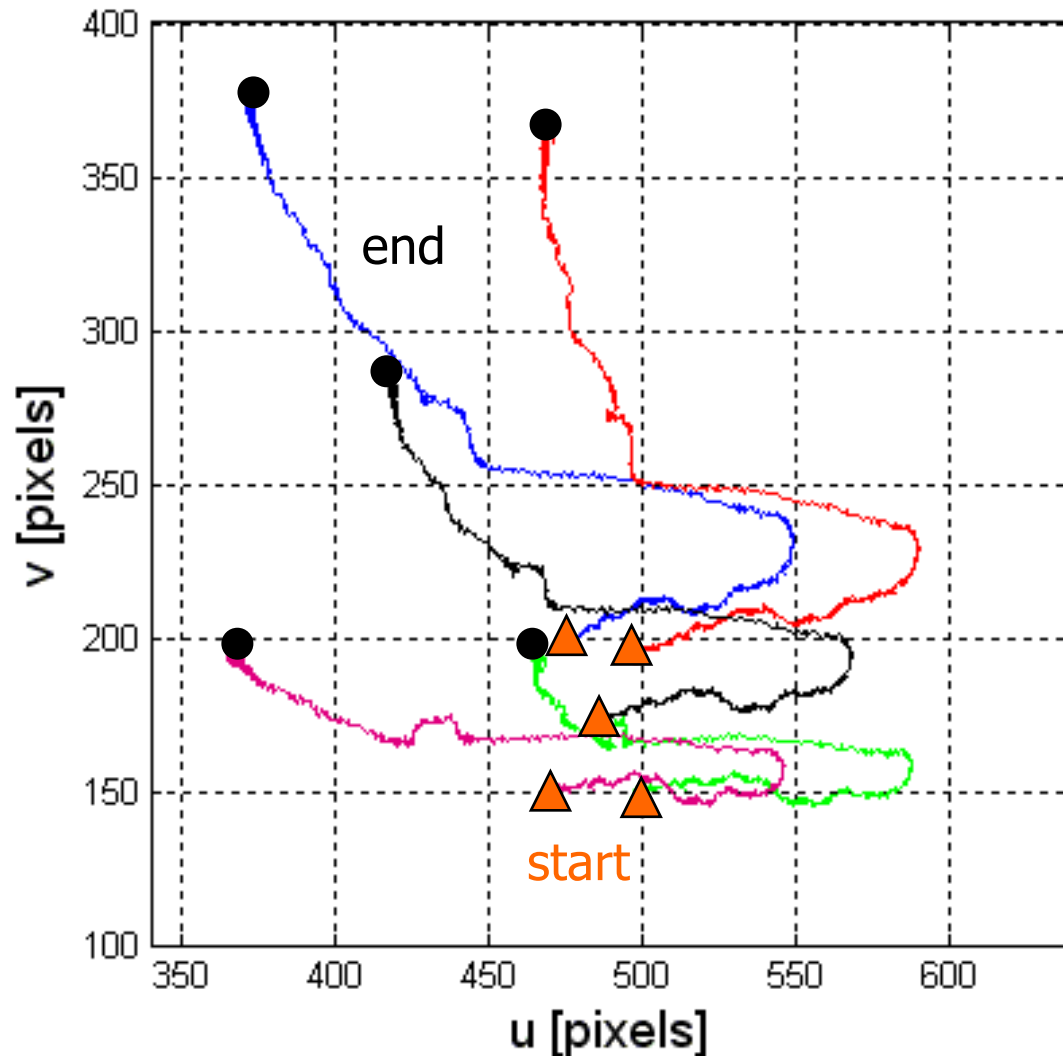

- motion of the 5 features (including the average point) in the image plane
- toward end, motion is  $\approx$  linear since the depth observers have already converged to the true values

- computed Image Jacobian is close to the actual one

$$\hat{Z} \rightarrow Z \Rightarrow \hat{J} \rightarrow J$$

- "true" initial and final depths

$$Z(t_0) \cong 4 \text{ m} \quad Z_d \cong 0.9 \text{ m}$$





# Experiments with the observer

- the same task was executed with **five different initializations** for the depth observers, ranging between **0.9 m** (= true depth in the **final** desired pose) and **16 m** (much larger than in the true **initial** pose)

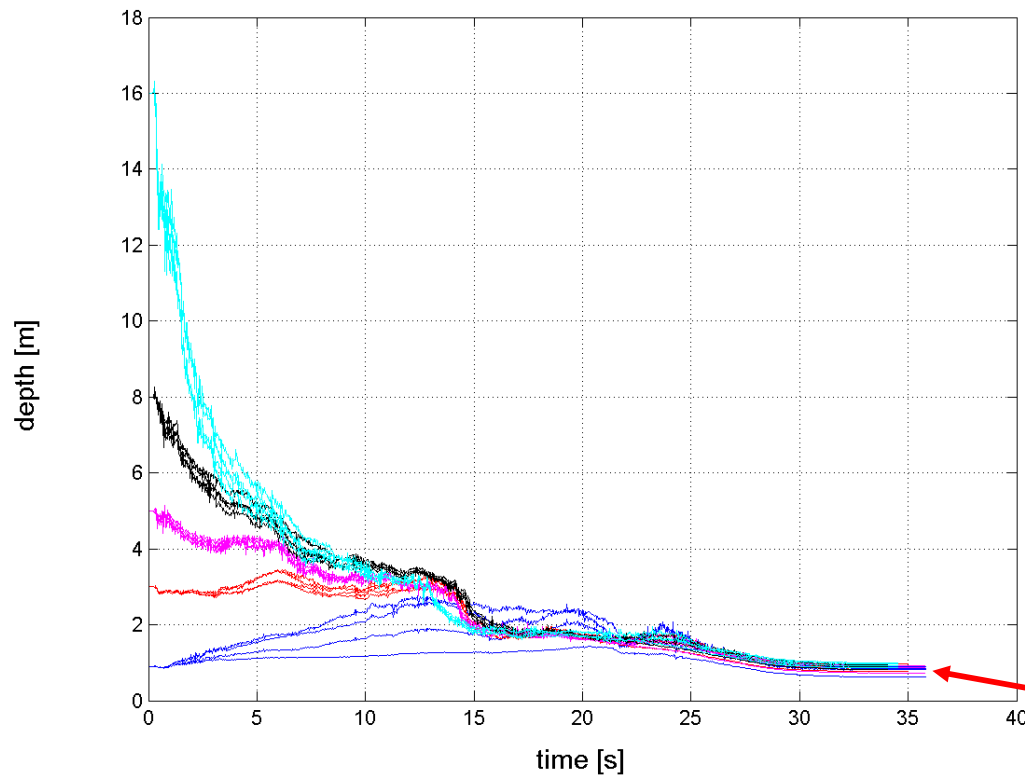

- initial values** of depth estimates in the five tests

$$\left\{ \begin{array}{l} \hat{Z}_1(t_0) = 16 \text{ m} \\ \hat{Z}_2(t_0) = 8 \text{ m} \\ \hat{Z}_3(t_0) = 5 \text{ m} \\ \hat{Z}_4(t_0) = 3 \text{ m} \\ \hat{Z}_5(t_0) = 0.9 \text{ m} \end{array} \right.$$

- true depths** in **initial** pose

$$Z(t_0) \cong 4 \text{ m}$$

- true depths** in **final** pose

$$Z_d \cong 0.9 \text{ m}$$

the evolutions of the **estimated** depths for the 4 point features



# Visual servoing with Kuka robot set-up

- Kuka KR5 sixx R650 manipulator (6 revolute joints, spherical wrist)
- Point Grey Flea<sup>©</sup>2 CCD camera, eye-in-hand (mounted on a support)
- Kuka KR C2sr low-level controller (RTAI Linux and Sensor Interface)
- image processing and visual servoing on PC (Intel Core2 @2.66GHz)
- high-level control data exchange every 12ms (via UDP protocol)

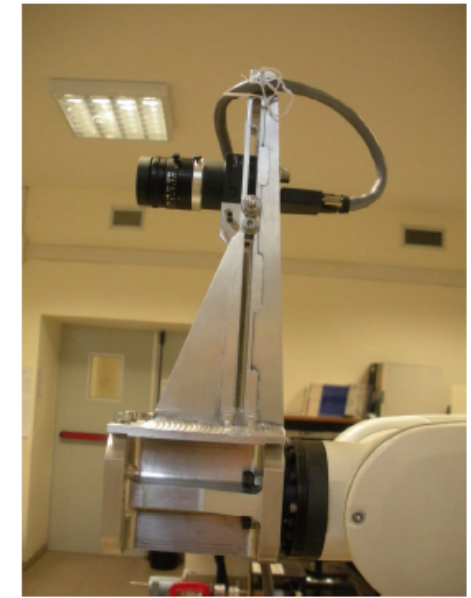

@ DIAG Robotics Laboratory

# Visual servoing with Kuka robot

## simulation and experiment with the observer

- depth estimation for a **fixed target** (single point feature)
- **simulation** using Webots first, then **experimental** validation
- **sinusoidal motion** of four robot joints so as to provide sufficient excitation

video

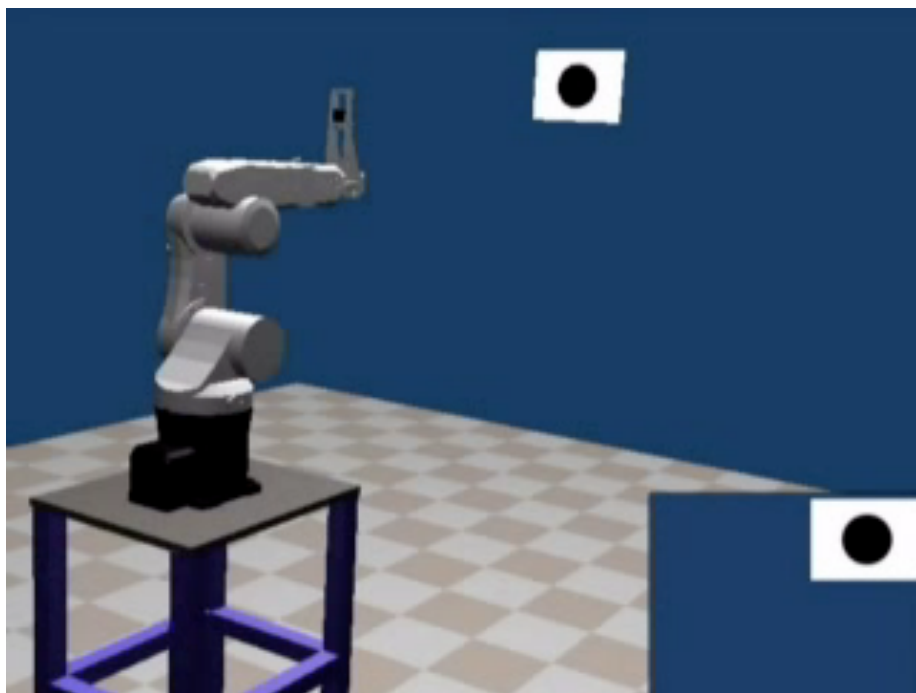

Webots simulation

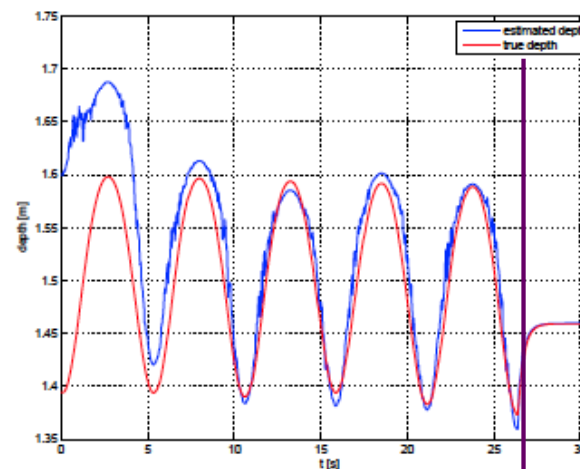

true and estimated depth

Kuka experiment

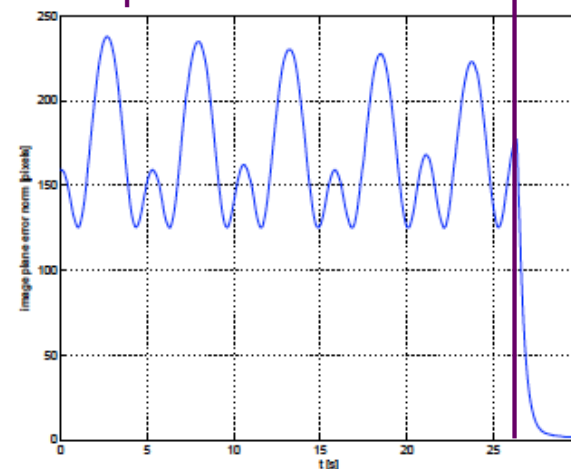

norm of centering error of feature point [in pixels]



goes to zero once control is activated

# Visual servoing with Kuka robot

## tracking experiment

- tracking a (slowly) **time-varying target** by visual servoing, including the depth observer (after convergence)

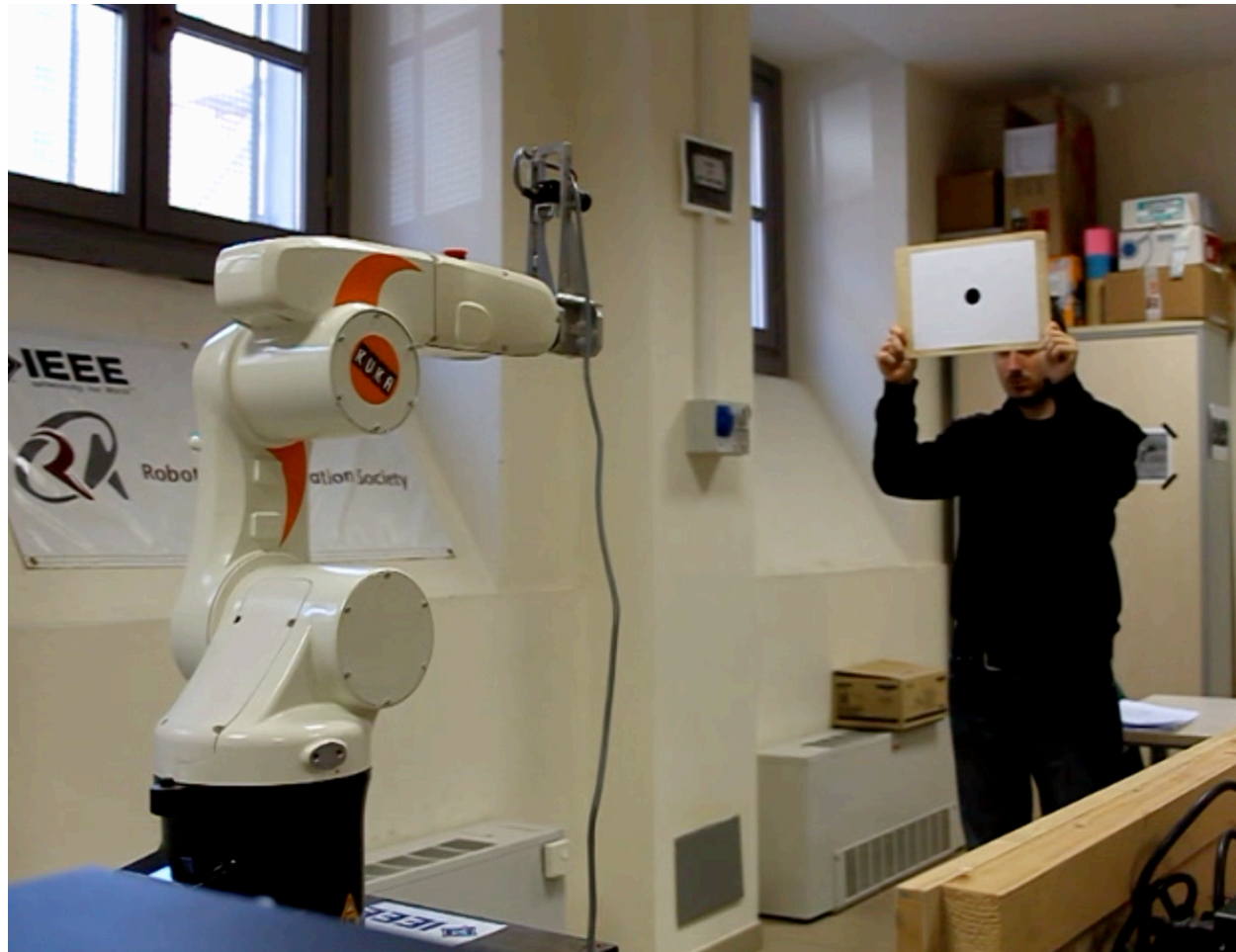

video

# Gazing with humanoid head

## stereo vision experiment

- gazing with a robotized head (7 joints, with  $n = 6$  independently controlled) at a **moving target** (visual task dimension  $m = 2$ ), using redundancy (to keep a better posture and avoid joint limits) and a **predictive feedforward**



[video](#) (c/o Fraunhofer IOSB, Karlsruhe)

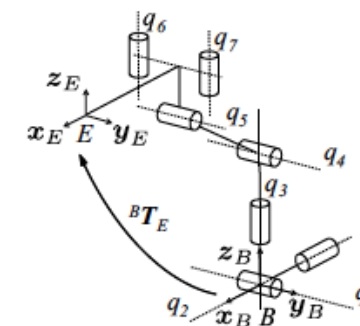

$$\dot{q} = J_W^\dagger(q) (\dot{\theta}_{fb} + \dot{\theta}_{ff}) - k_0 (I - J_W^\dagger(q) J(q)) \nabla_q H_0(q)$$

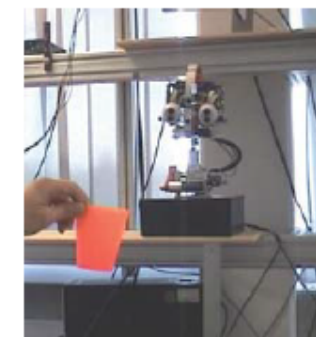
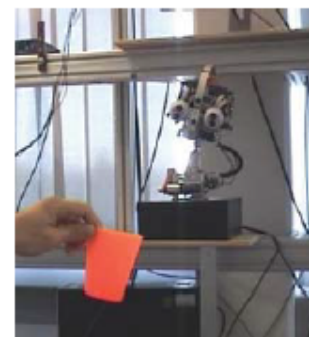

final head posture  
without and with self-motions